

catalogus

Interieuraccessoires & garderobesystemen

Bau- und Möbelbeschläge & Garderoben

Interior hardware & cloakroom systems

Quincaillerie intérieure & vestiaires

2023 | 2024



hermeta

OUR COLOURS

geanodiseerd | eloxiert | anodized | anodisé



01

naturel
silber
silver
argent



11

mat naturel
matt silber
matt silver
argent mat



18

zwart
schwarz
black
noir

geëpoxeerd | pulverbeschichtet | epoxy plastic coated | thermolaqué



18

zwart
schwarz
black
noir
RAL 9005



70

zwart
schwarz
black
noir
RAL 9005



74

grafiet grijs
graphit grau
graphite grey
gris graphite
RAL 7024



79

wit
weiß
white
blanc
RAL 9010

hout | Holz | wood | bois



36

eikenhout,
geborsteld
Eichenholz,
gebürstet
brushed oak
wood
chêne
brossé

gepolijst | poliert | polished | poli



93

kunststof | Kunststoff | plastic | plastique



80

zwart*
schwarz*
black*
noir*

*gerecycled kunststof
*recycler Kunststoff
*recycled plastic
*plastique recyclé



INHOUDSOPGAVE

HOOFDSTUK 1	HAKEN EN KAPSTOKGARNITUREN		
	- Hoed- en jashaken	12	t/m 23
	- Handdoekhaken	24	t/m 26
	- Handdoekrekjes	27	
	- Hakenrekjes	28	
	- Kastroedebuis	29	
	- Schuifhaken	30	
	- Kapstokgarnituren	31	t/m 33
	- Wandgarderobe	34	t/m 35
HOOFDSTUK 2	LEUNINGHOUDERS		
	- Gegoten leuninghouders	38	t/m 41
	- Samengestelde leuninghouders	42	t/m 43
	- Profiel leuninghouders	44	t/m 47
	- Verstelbare afstandhouders	48	
HOOFDSTUK 3	GREPEN EN MEUBELKNOPPEN		
	- Meubelknoppen	52	t/m 54
	- Ladegrepen	55	t/m 56
	- Profiel handgrepen	57	t/m 58
	- Gegoten handgrepen	59	t/m 60
	- Raamlichters en raampennen	61	
HOOFDSTUK 4	SCHUIFDEURKOMMEN		
	- Ronde schuifdeurkommen	64	
	- Rechthoekige schuifdeurkommen	65	
	- Ovale schuifdeurkommen	66	
HOOFDSTUK 5	DEURBUFFERS EN DEURDUWERS		
	- Wand deurbuffers	70	
	- Vloer deurbuffers	71	t/m 72
	- Deurduwers	73	
HOOFDSTUK 6	DOORVALBEVEILIGING		
	- Doorvalbeveiligingsbuis vierkant	77	
	- Doorvalbeveiligingsbuis rond/ovaal	77	
	- Doorvalbeveiligingssteuntjes	77	
HOOFDSTUK 7	DIVERSEN EN BEVESTIGINGSMATERIAAL		
	- Wandafvalbakken	82	
	- Dopmoeren	83	
	- Stokschroef	84	
HOOFDSTUK 8	GARDEROBES		
	- Gardelux 1 garderobes	90	t/m 97
	- Gardelux 1 losse onderdelen	98	t/m 108
	- Gardelux 2 garderobes	110	t/m 118
	- Gardelux 2 losse onderdelen	119	t/m 127
HOOFDSTUK 9	ZITBANKEN		
	- Gardelux zitbanken	130	t/m 133
	- Gardelux zitbanken losse onderdelen	134	t/m 136
HOOFDSTUK 10	GARDEROBEFRAMES EN KAPSTOKKEN		
	- Garderobeframes	140	t/m 141
	- Stelvoeten en zwenkwielen	142	
	- Staande kapstokken	143	
NUMMERREGISTER		144	t/m 145





KAPITEL 1	HAKEN UND GARDEROBENLEISTEN	
	- Hut- und Mantelhaken	12 bis 23
	- Handtuchhaken	24 bis 26
	- Handtuchleisten	27
	- Hakenleisten	28
	- Schrankrohre	29
	- Schiebehaken	30
	- Garderobenleisten	31 bis 33
	- Hakenleiste	34 bis 35
KAPITEL 2	HANDLAUFSTÜTZEN	
	- Gegossene Handlaufstütze	38 bis 41
	- Zusammengesetzte Handlaufstütze	42 bis 43
	- Profil Handlaufstütze	44 bis 47
	- Verstellbare Abstandshalter	48
KAPITEL 3	GRIFFE UND MÖBELKNÖPFE	
	- Möbelknöpfe	52 bis 54
	- Schubladengriffe	55 bis 56
	- Profilgriffe	57 bis 58
	- Gegossene Griffe	59 bis 60
	- Fenstergriffe und Fenstersicherung	61
KAPITEL 4	MUSCHELGRIFFE	
	- Muschelgriffe, rund	64
	- Muschelgriffe, rechteckig	65
	- Muschelgriffe, oval	66
KAPITEL 5	TÜRPUFFER UND DRÜCKER	
	- Wandtürpuffer	70
	- Bodentürpuffer	71 bis 72
	- Türgriffe	73
KAPITEL 6	ABSTURZSCHUTZ	
	- Absturzschutzrohr quadratisch	77
	- Absturzschutzrohr rund/oval	77
	- Absturzschutzstütze	77
KAPITEL 7	SONSTIGES UND BEFESTIGUNGSMATERIAL	
	- Wand Abfallbehälter	82
	- Hutmutter	83
	- Stockschraube	84
KAPITEL 8	GARDEROBEN	
	- Gardelux 1 Garderoben	90 bis 97
	- Gardelux 1 lose Teile	98 bis 108
	- Gardelux 2 Garderoben	110 bis 118
	- Gardelux 2 lose Teilen	119 bis 127
KAPITEL 9	SITZBÄNKE	
	- Gardelux Sitzbänke	130 bis 133
	- Gardelux Sitzbänke lose Teile	134 bis 136
KAPITEL 10	RAHMEN FÜR GARDEROBEN UND GARDEROBENSTÄNDER	
	- Rahmen für Garderoben	140 bis 141
	- Stellfuß und Lenkrolle	142
	- Freistehender Garderobenständer	143
NUMMERNREGISTER		144 bis 145



INDEX

CHAPTER 1	HOOKS AND COAT RACKS		
	- Hat and coat hooks	12	to 23
	- Towel hooks	24	to 26
	- Towel hooks on rails	27	
	- Coat racks	28	
	- Cupboard tube	29	
	- Sliding hooks	30	
	- Coat racks	31	to 33
	- Coat rack system	34	to 35
CHAPTER 2	HANDRAIL BRACKETS		
	- Cast handrail brackets	38	to 41
	- Composed handrail brackets	42	to 43
	- Profile handrailbrackets	44	to 47
	- Adjustable brackets	48	
CHAPTER 3	HANDLES AND FURNITURE KNOBS		
	- Cupboard knobs	52	to 54
	- Cupboard handles	55	to 56
	- Profile handles	57	to 58
	- Cast handles	59	to 60
	- Window handles and sash pins	61	
CHAPTER 4	FLUSH PULLS		
	- Round flush pulls	64	
	- Rectangular flush pulls	65	
	- Oval flush pulls	66	
CHAPTER 5	DOOR STOPS AND PUSH PADS		
	- Wall door stop	70	
	- Floor door stop	71	to 72
	- Push pads	73	
CHAPTER 6	FALL-THROUGH PROTECTION		
	- Fal-through protection tube square	77	
	- Fall-through protection tube round/oval	77	
	- Fall-through protection supports	77	
CHAPTER 7	MISCELLANEOUS AND FASTENERS		
	- Wall mounted waste bins	82	
	- Dome headed nuts	83	
	- Hanger bolt	84	
CHAPTER 8	WARDROBE SYSTEMS		
	- Gardelux 1 coat racks	90	to 97
	- Gardelux 1 loose parts	98	to 108
	- Gardelux 2 coat racks	110	to 118
	- Gardelux 2 loose parts	119	to 127
CHAPTER 9	BENCHES		
	- Gardelux benches	130	to 133
	- Gardelux benches loose parts	134	to 136
CHAPTER 10	COAT RACK FRAMES AND COAT STANDS		
	- Coat rack frames	140	to 141
	- Adjustable feet and castors	142	
	- Coat stands	143	
NUMBER REGISTER		144	to 145



TABLE DES MATIÈRES

CHAPITRE 1	CROCHETS ET PORTE-MANTEAUX		
	- Crochets porte-chapeaux et porte-manteaux	12	à 23
	- Crochets pour essuie-mains	24	à 26
	- Porte-serviettes	27	
	- Support à crochets	28	
	- Tubes d'armoire	29	
	- Crochets glissant	30	
	- Porte-manteaux	31	à 33
	- Porte-manteaux, système	34	à 35
CHAPITRE 2	SUPPORTS DE MAIN COURANTE		
	- Supports de main courante moulées	38	à 41
	- Supports de main courante composé	42	à 43
	- Supports de main courante profilé	44	à 47
	- Support réglable	48	
CHAPITRE 3	POIGNÉES ET BOUTONS DE MEUBLE		
	- Boutons de meuble	52	à 54
	- Poignées de meuble	55	à 56
	- Poignées profilé	57	à 58
	- Poignées moulées	59	à 60
	- Poignées pour fenestres et goupille	61	
CHAPITRE 4	POIGNÉE CUVETTE POUR PORTE COULISSANTE		
	- Poignée cuvette ronde	64	
	- Poignée cuvette rectangulaire	65	
	- Poignée cuvette ovale	66	
CHAPITRE 5	BUTOIR DE PORTE ET POIGNÉES DE PORTE		
	- Butoir de porte murale	70	
	- Butoir de porte au sol	71	à 72
	- Poignées de porte	73	
CHAPITRE 6	PROTECTION CONTRE LES CHUTES		
	- Barre de protection carré	77	
	- Barre de protection rond/ovale	77	
	- Supports	77	
CHAPITRE 7	DIVERS ET MATÉRIEL DE FIXATION		
	- Poubelles murales	82	
	- Écrous borgnes	83	
	- Boulon de suspension	84	
CHAPITRE 8	VESTIAIRES		
	- Vestiaires Gardelux 1	90	à 97
	- Pièces détachées Gardelux 1	98	à 108
	- Vestiaires Gardelux 2	110	à 118
	- Pièces détachées Gardelux 2	119	à 127
CHAPITRE 9	BANCS		
	- Bancs Gardelux	130	à 133
	- Pièces détachées bancs Gardelux	134	à 136
CHAPITRE 10	CADRES DE VESTIAIRE ET PORTE-MANTEAUX		
	- Cadres de vestiaires	140	à 141
	- Pieds réglable et roulettes pivotante	142	
	- Porte -manteau à pied	143	
REGISTRE DE NUMÉRO		144	à 145





In het idyllische Asperen aan de rivier de Linge, midden in de Betuwe, is Hermeta sinds 1946 gevestigd. Wat ooit in 1924 in Rotterdam is begonnen als metaalbewerkingsbedrijf is inmiddels uitgegroeid tot internationaal maakbedrijf in bouw en interieur met drie divisies: Hermeta Bouw- en meubelbeslag, Hermeta Gevelbouw en Hermeta Interieurbouw. Hoewel de drie bedrijven zelfstandig opereren, wordt er ook samengewerkt in projecten. De expertise van alle drie de divisies maakt dat we een totaalconcept kunnen aanbieden als het gaat om aluminium maatwerkoplossingen.

DUURZAAMHEID EN KWALITEIT

Vanaf de productie tot aan de levering staan kwaliteit en duurzaamheid bij Hermeta in het middelpunt. De perfecte en vooral hoogwaardige afwerking van onze producten laat dit zien. Voorwaarden voor deze hoogwaardige en duurzame producten zijn ook terug te zien in de certificering die Hermeta hanteert. Al het bouw- meubelbeslag en de garderobesystemen zijn Cradle to Cradle gecertificeerd. We zien dat onze eigen voetafdruk impact heeft op de wereld. Met deze certificering tonen wij aan dat onze producten veilig, circulair en verantwoordelijk zijn geproduceerd. Volgend op duurzaamheid draagt Hermeta ook het FSC-certificaat. Niet alleen onze producten zijn duurzaam en van hoge kwaliteit; aan onze processen worden ook deze eisen gesteld. We volgen hierin de internationaal geharmoniseerde normen ISO 9001 en ISO 14001 zodat we onze processen en producten met trots kunnen waarborgen en presenteren.

DEZE CATALOGUS

In deze catalogus vindt u een overzicht van onze interieuraccessoires en Gardelux producten. De hoofdstukken zijn ingedeeld op productgroep en elk hoofdstuk is eenvoudig te herkennen door zijn eigen symbool, geplaatst aan de rechterzijde van elke pagina. Van jashaken tot leuninghouders en van ons vertrouwde Gardelux garderobesysteem tot onze doorvalbeveiliging "Vast en Zeker".

Wilt u meer weten over ons assortiment of heeft u advies nodig? Neem contact met ons op.

ALUMINIUM, EEN BIJZONDER MATERIAAL

Aluminium is een licht metaal en door toevoeging van legeringselementen is het ook een sterk metaal. De aluminiumlegeringen die Hermeta toepast, waaronder het eigen L45, zijn optimaal om een mooi en sterk product te maken met veel vormvrijheid. Producten van aluminium gaan lang mee. Hermeta garandeert zelfs dat haar producten levenslang 100% corrosievrij blijven. Wordt het product toch afgedankt, dan kan het aluminium weer door Hermeta worden hergebruikt. Dit maakt het een ideaal materiaal voor een circulaire wereld.

Het oppervlak van aluminium is zeer dicht en ondoordringbaar. Het is een dermatologisch vriendelijk materiaal. Daarmee is het een uitkomst voor toepassingen waar hoge hygiënische eisen aan worden gesteld.

Hermeta verwerkt aluminiumprofielen in diverse producten en heeft eigen productiefaciliteiten in Nederland voor geobotiseerd en handmatig gieten van aluminium.

OPPERVLAKTEBEHANDELINGEN: ANODISEREN EN POEDERCOATEN

Aluminium heeft van nature een gesloten oxidelaag, die het onderliggende metaal beschermt. Anodiseren is het aanbrengen van een kunstmatige, sterk verdichte aluminium oxidelaag die in een nat chemisch proces ontstaat onder invloed van stroom. De anodiseerlaag is hard, beschermt tegen corrosie en geeft het product een mooier uiterlijk. Hermeta kan haar aluminium producten zelf anodiseren en biedt geanodiseerd aluminium in diverse kleuren aan. Dit zijn materiaal-eigen kleuren met een mooie kwaliteitsuitstraling.

Poedercoaten, ook wel epoxeren genoemd, is een tweede mogelijkheid van oppervlaktebehandeling. Hermeta laat haar producten poedercoaten in aluminium gespecialiseerde lakkerijen, zodat ook hier levenslange corrosiebestendigheid kan worden gegarandeerd. Met poedercoaten zijn alle RAL kleuren mogelijk. Hermeta biedt een aantal RAL-kleuren standaard aan.





Im idyllischen Städtchen Asperen am Fluss Linge, mitten in der Landschaft der Betuwe, ist seit 1946 die Firma Hermeta ansässig. Was einst im Jahr 1924 als metallverarbeitender Betrieb in Rotterdam begann, hat sich inzwischen zu einem internationalen Fertigungsunternehmen mit drei Geschäftsbereichen in der Baubranche und dem Innenausbau entwickelt: Hermeta Bau- und Möbelbeschläge, Hermeta Fassadenbau und Hermeta Innenausbau. Obwohl alle drei Unternehmensbereiche unabhängig voneinander operieren, arbeiten sie bei Projekten auch zusammen. Das Know-how aller drei Geschäftsbereiche ermöglicht es uns, ein Gesamtkonzept für maßgeschneiderte Aluminiumlösungen anzubieten.

NACHHALTIGKEIT UND QUALITÄT

Bei Hermeta stehen von der Produktion bis zur Lieferung Qualität und Nachhaltigkeit im Mittelpunkt. Die perfekte und vor allem hochwertige Verarbeitung unserer Produkte ist der Beweis dafür. Die Anforderungen an unsere hochwertigen und nachhaltigen Produkte spiegeln sich auch in der Zertifizierung wider, die Hermeta beständig aufrechterhält. Alle Bau- und Möbelbeschläge sowie Garderobensysteme verfügen über eine Cradle-to-Cradle-Zertifizierung. Uns ist bewusst, dass unser eigener Fußabdruck Auswirkungen auf den Planeten hat. Mit der Zertifizierung zeigen wir, dass unsere Produkte sicher, zirkulär und verantwortungsbewusst produziert werden. Hermeta verfügt im Sinne der Nachhaltigkeit zudem über das FSC-Zertifikat. Doch nicht nur unsere Produkte sind nachhaltig und von hoher Qualität, auch unsere Herstellungsverfahren unterliegen strengen Anforderungen. Wir orientieren uns dabei an den international harmonisierten Normen ISO 9001 und ISO 14001, sodass wir unsere Verfahren und Produkte mit Stolz präsentieren und die volle Gewährleistung dafür übernehmen können.

DIESER KATALOG

Dieser Katalog gibt Ihnen einen Überblick über unser Zubehör für den Innenausbau und die Produkte von Gardelux. Die Kapitel sind nach Produktgruppen gegliedert, wobei jedes Kapitel auf einfache Weise an einem eigenen Symbol am rechten Rand jeder Seite zu erkennen ist. Von Kleiderhaken bis zu Handlaufhaltern und von unserem bewährten Gardelux-Garderobensystem bis zu unserem Durchsturzschutz "Vast en Zeker".

Sie möchten mehr über unsere Produktpalette erfahren oder sich beraten lassen? Setzen Sie sich mit uns in Verbindung.

ALUMINIUM, EIN BESONDERER WERKSTOFF

Aluminium ist ein Leichtmetall. Erst die Zugabe von Legierungselementen macht es zu einem Starkmetall. Die von Hermeta eingesetzten Aluminiumlegierungen, darunter das eigene L45, sind optimal für die Herstellung eines formschönen und haltbaren Produkts mit viel Formfreiheit. Produkte aus Aluminium haben eine lange Lebensdauer. Hermeta gewährleistet darüber hinaus, dass seine Produkte ein Leben lang zu 100 % korrosionsfrei sind. Wird ein Produkt dennoch entsorgt, kann das Aluminium von Hermeta wiederverwendet werden. Das macht es zu einem idealen Material für die zirkuläre Wertschöpfungskette.

Die Oberfläche von Aluminium ist fest geschlossen und undurchlässig. Dadurch ist es ein dermatologisch verträgliches Material. Das macht es zu einem idealen Stoff für Anwendungen mit hohen Hygieneanforderungen.

Hermeta verarbeitet Aluminiumprofile zu verschiedenen Produkten und verfügt in den Niederlanden über eigene Produktionsstätten für den robotergestützten und manuellen Aluminiumguss.

OBERFLÄCHENBEHANDLUNG: ELOXIERUNG UND PULVERBESCHICHTUNG

Aluminium hat von Natur aus eine geschlossene Oxidschicht, die das darunter liegende Metall schützt. Unter Eloxieren versteht man das Auftragen einer künstlichen, stark verdichteten Aluminiumoxidschicht, die in einem nasschemischen Verfahren unter Einwirkung von Elektrizität erzeugt wird. Die Eloxidschicht ist hart, schützt vor Korrosion und verleiht dem Produkt ein schöneres Aussehen. Hermeta kann seine Aluminiumprodukte selbst eloxieren und bietet eloxiertes Aluminium in verschiedenen Farben an. Es handelt sich dabei um materialspezifische Farben mit einem schönen, qualitativ hochwertigen Erscheinungsbild.

Eine zweite Möglichkeit der Oberflächenbehandlung ist die Pulverbeschichtung, auch Epoxidierung genannt. Hermeta lässt seine Produkte in auf Aluminium spezialisierten Pulverbeschichtungsbetrieben pulverbeschichten, so dass auch hier eine lebenslange Korrosionsbeständigkeit gewährleistet werden kann. Bei der Pulverbeschichtung sind alle RAL-Farben möglich. Eine Reihe von RAL-Farben werden von Hermeta als Standard angeboten.

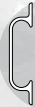



Hermeta has been based in the idyllic village of Asperen on the Linge since 1946. What started as a metalworking company in Rotterdam in 1924 has since developed into an international manufacturing company in building and furniture hardware with three divisions: Hermeta Bouw- en meubelbeslag, Hermeta Gevelbouw and Hermeta Interieurbouw. Although the three companies operate independently, they also cooperate in projects. The expertise of all three divisions combined means we can offer an overall concept for customised aluminium solutions.

SUSTAINABILITY AND QUALITY

From production to delivery, quality and sustainability are our guiding principles. This is demonstrated by the perfect and extremely high-quality finish of our products. The conditions to which our high-quality, sustainable products are subject are reflected in the certification Hermeta applies. All building and furniture hardware and the coat rack systems have Cradle to Cradle certification. We recognise that our footprint has an impact on the planet. By using this certification, we show that our products have been made in a manner that is safe, circular and responsible. Our sustainability goals are also reflected in our FSC certification. It is not only our products that are sustainable and of a high quality – we expect the same from our processes. We follow the internationally harmonised ISO 9001 and ISO 14001 standards for this purpose, so we can guarantee and present our processes and products with pride.

THIS CATALOGUE

In this catalogue, you will find an overview of our interior accessories and Gardelux products. It is divided into chapters by product group, and each chapter can be easily recognised by its own symbol in the right margin of each page. You will find everything from coat hooks to handrail brackets and from our trusted Gardelux coat rack system to our "Vast en Zeker" (solid and secure) window guards.

Would you like to know more about our product range or do you need advice? Please contact us.

ALUMINIUM, A UNIQUE MATERIAL

Aluminium is a light metal, and by adding alloying elements, it also becomes a strong metal. The alloying elements used by Hermeta, including our own L45, are perfect for manufacturing a strong, beautiful product with a high level of freedom of design. Aluminium products last a long time. At Hermeta, we even guarantee that our products will remain 100% corrosion-free throughout their service life. If the product is nevertheless discarded, Hermeta can reuse the aluminium. This makes it the perfect material for a circular economy.

The surface of aluminium is very dense and impermeable. It is a dermatologically friendly material. It therefore provides a great solution for applications with high hygienic requirements.

Hermeta processes aluminium profiles in a number of products and has its own production facilities in the Netherlands for the automated and manual pouring of aluminium.

SURFACE TREATMENTS: ANODISATION AND POWDER-COATING

Aluminium has a closed oxide layer by nature, which protects the underlying metal. Anodisation is the application of an artificial, highly densified aluminium oxide layer, which is formed in a wet chemical process under the influence of electricity. The anodisation layer is hard, protects against corrosion and gives the product a more attractive appearance. At Hermeta, we can anodise our aluminium products, and we can offer anodised aluminium in different colours. These are material-specific colours with a high-quality appearance.

Powder-coating, also called epoxy-coating, is another option for surface treatment. We get our products powder-coated in paintshops specialising in aluminium, so we can again guarantee our products are corrosion-proof for the duration of their service life. Powder-coating can be done in all RAL colours. Hermeta offers a number of RAL colours in its standard range.





La société Hermeta est établie depuis 1946 au bord de la rivière Linge dans le village idyllique d'Asperen, au centre de la Betuwe, région naturelle des Pays-Bas. Ce qui était au début, en 1924, une entreprise d'usinage des métaux est devenu entretemps une entreprise manufacturière internationale dans la construction et le design d'intérieur avec trois divisions : Hermeta Matériels pour construction et mobilier, Hermeta Construction de façade et Hermeta Aménagement d'intérieur. Bien que les trois entreprises opèrent de manière autonome, elles travaillent également conjointement sur des projets. Grâce à l'expertise de l'ensemble des trois divisions, nous pouvons proposer un concept total lorsqu'il s'agit de solutions sur mesure à base d'aluminium.

DURABILITÉ ET QUALITÉ

De la production jusqu'à la livraison, la qualité et la durabilité sont au cœur de la société Hermeta. La finition parfaite et surtout de haute qualité de nos produits le prouve. Les conditions pour ces produits de haute qualité et durables se retrouvent également dans la certification qu'applique Hermeta. L'ensemble des matériels de construction et de mobilier et les systèmes de vestiaire sont certifiés Cradle to Cradle. Nous voyons que notre propre empreinte a un impact sur le monde. Avec cette certification, nous montrons que nos produits sont réalisés de manière sûre, circulaire et responsable. Dans le cadre de la durabilité, Hermeta porte également le certificat FSC. Non seulement nos produits sont durables et de haute qualité, mais ces exigences sont également posées sur nos processus. Nous suivons en la matière les normes harmonisées au niveau international ISO 9001 et ISO 14001, de sorte que nous pouvons garantir et présenter avec fierté nos processus et nos produits.

CE CATALOGUE

Dans ce catalogue, vous trouverez un aperçu de nos accessoires d'intérieur et produits Gardelux. Les chapitres sont divisés par groupe de produits et chaque chapitre est facilement reconnaissable à son propre symbole, placé sur le côté droit de chaque page. Des patères aux supports de mains courantes et de notre système de vestiaire Gardelux familier jusqu'à notre protection antichute "Vast en Zeker".

Vous voulez en savoir plus sur notre assortiment ou vous avez besoin d'un conseil ? Prenez contact avec nous.

L'ALUMINIUM, UN MATÉRIAU SPÉCIAL

L'aluminium est un métal léger et grâce à l'ajout d'éléments d'alliage, c'est également un métal solide. Les alliages d'aluminium qu'utilise Hermeta, parmi lesquels le propre alliage L45, constituent le composant optimal pour réaliser un produit beau et robuste avec une grande liberté de forme. Les produits en aluminium durent longtemps. Hermeta garantit même que ses produits demeurent exempts de corrosion à 100 % pendant toute leur durée de vie. Si le produit est néanmoins mis au rebut, l'aluminium peut être réutilisé par Hermeta, ce qui en fait un matériau idéal pour un monde circulaire.

La surface de l'aluminium est très dense et impénétrable. C'est un matériau respectueux de la peau. Il convient par conséquent à des applications pour lesquelles de hautes exigences sont posées en matière d'hygiène.

Hermeta transforme des profilés d'aluminium en divers produits et la société possède ses propres installations de production aux Pays-Bas, pour la fonte robotisée et manuelle de l'aluminium.

TRAITEMENTS DE SURFACE : ANODISATION ET REVÊTEMENT PAR POWDRAGE

Par nature, l'aluminium possède une couche d'oxyde fermée, qui protège le métal qui se trouve en dessous. L'anodisation consiste à appliquer une couche artificielle d'oxyde d'aluminium très compacte, qui est créée dans un procédé chimique humide sous l'influence du courant. La couche d'anodisation est dure, elle protège contre la corrosion et donne au produit un plus bel aspect. Hermeta peut anodiser elle-même ses produits en aluminium et elle propose de l'aluminium anodisé en diverses couleurs. Il s'agit de couleurs du propre matériau avec un bel aspect qualitatif.

Le revêtement par poudrage, également connu sous le nom de revêtement d'époxy, représente une deuxième possibilité de traitement de surface. Hermeta confie le revêtement par poudrage de ses produits à des ateliers de peinture spécialisés dans l'aluminium, de sorte qu'ici aussi, une résistance à la corrosion à vie puisse être garantie. Avec le revêtement par poudrage, toutes les couleurs RAL sont possibles. Hermeta propose de manière standard un certain nombre de couleurs RAL.





1 Haken en kapstokgarnituren

1 Haken und Garderobenleisten

1 Hooks and coat racks

1 Crochets et porte-manteaux



HOED- EN JASHAKEN

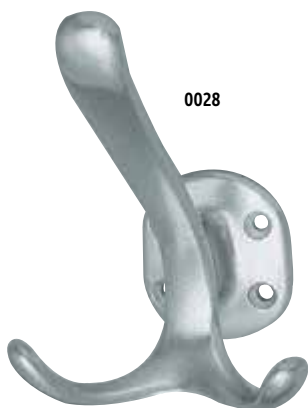

0028



0029

HOED- EN JASHAKEN	HUT- UND MANTELHAKEN	HAT AND COAT HOOKS	CROCHETS PORTECHAPEAU et PORTEMANTEAU
gegoten aluminium	Aluminiumguss	cast aluminium	en fonte d'aluminium

geanodiseerd
-01 naturel

eloxiert
-01 silber

anodized
-01 silver

anodisé
-01 argent

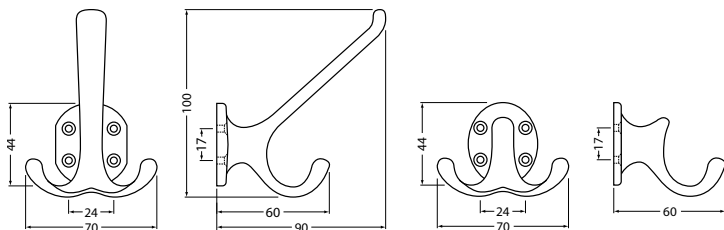

HOED- EN JASHAKEN



0030



0031

HOED- EN JASHAKEN	HUT- UND MANTELHAKEN	HAT AND COAT HOOKS	CROCHETS PORTECHAPEAU ET PORTEMANTEAU
gegoten aluminium	Aluminiumguss	cast aluminium	en fonte d'aluminium
geanodiseerd -01 naturel	eloxiert -01 silber	anodized -01 silver	anodisé -01 argent
geëpoxeerd -70 zwart	pulverbeschichtet -70 schwarz	epoxy plastic coated -70 black	thermolaqué -70 noir

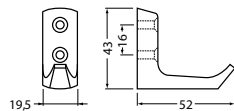
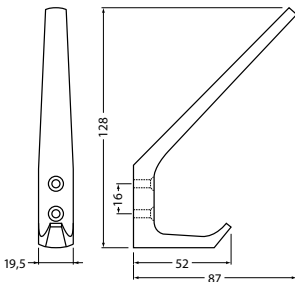

HOED- EN JASHAKEN



0032



0033

HOED- EN JASHAKEN	HUT- UND MANTELHAKEN	HAT AND COAT HOOKS	CROCHETS PORTECHAPEAU ET PORTEMANTEAU
gegoten aluminium	Aluminiumguss	cast aluminium	en fonte d'aluminium
geanodiseerd -01 naturel	eloxiert -01 silber	anodized -01 silver	anodisé -01 argent
geëpoxeerd -70 zwart	pulverbeschichtet -70 schwarz	epoxy plastic coated -70 black	thermolaqué -70 noir

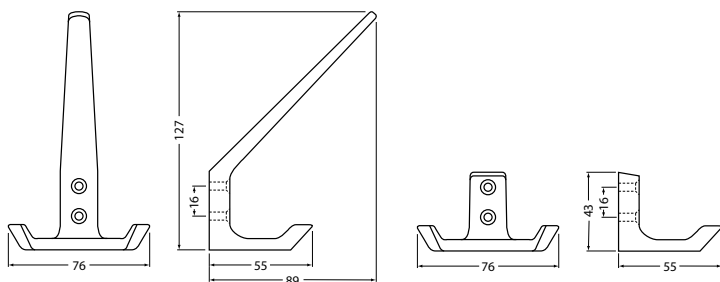

HOED- EN JASHAKEN



0111



0115



HAKEN XL	HAKEN XL	HOOKS XL	CROCHETS XL
van aluminium profiel	Aluminiumprofiel	extruded aluminium	en profilé d'aluminium
geanodiseerd -01 naturel -11 mat naturel	eloxiert -01 silber -11 matt silber	anodized -01 silver -11 matt silver	anodisé -01 argent -11 argent mat
geëpoxeerd -18 zwart	pulverbeschichtet -18 schwarz	epoxy plastic coated -18 black	thermolaqué -18 noir

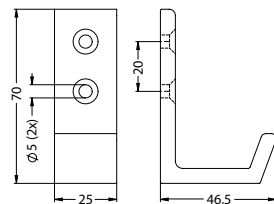
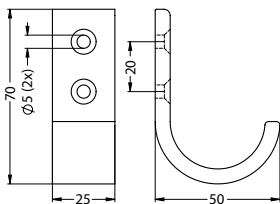

HOED- EN JASHAKEN



0129

HAKEN	HAKEN	HOOKS	CROCHETS
van aluminium profiel	Aluminiumprofiel	extruded aluminium	en profilé d'aluminium
geanodiseerd -01 naturel -11 mat naturel	eloxiert -01 silber -11 matt silber	anodized -01 silver -11 matt silver	anodisé -01 argent -11 argent mat
geëpoxideerd -18 zwart	pulverbeschiktet -18 schwarz	epoxy plastic coated -18 black	thermolaqué -18 noir

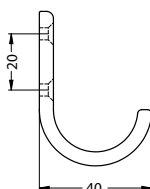
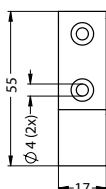

HOED- EN JASHAKEN



0138



0139

HOED- EN JASHAKEN	HUT- UND MANTELHAKEN	HAT- AND COAT HOOKS	CROCHETS PORTECHAPEAU ET PORTEMANTEAU
van aluminium profiel	Aluminiumprofiel	extruded aluminium	en profilé d'aluminium
geanodiseerd -01 naturel -11 mat naturel	eloxiert -01 silber -11 matt silber	anodized -01 silver -11 matt silver	anodisé -01 argent -11 argent mat
geëpoxeerd -18 zwart -79 wit	pulverbeschiktet -18 schwarz -79 weiß	epoxy plastic coated -18 black -79 white	thermolaqué -18 noir -79 blanc

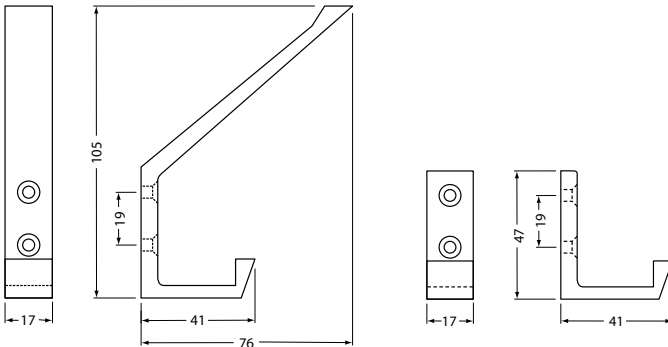

HOED- EN JASHAKEN



0148



0149

HOED- EN JASHAKEN	HUT- UND MANTELHAKEN	HAT- AND COAT HOOKS	CROCHETS PORTECHAPEAU ET PORTEMANTEAU
van aluminium profiel	Aluminiumprofil	extruded aluminium	en profilé d'aluminium
geanodiseerd -01 naturel -11 mat naturel	eloxiert -01 silber -11 matt silber	anodized -01 silver -11 matt silver	anodisé -01 argent -11 argent mat
geëpoxideerd -18 zwart	pulverbeschichtet -18 schwarz	epoxy plastic coated -18 black	thermolaqué -18 noir

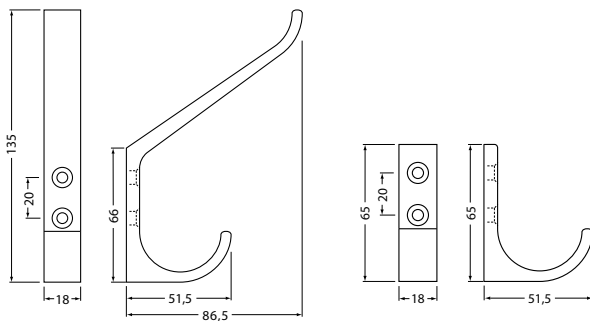

HOED- EN JASHAKEN



0150

MAGNEETHAAK	MAGNETHAKEN	MAGNETIC HOOKS	PATÈRES MAGNÉTIQUE
van aluminium profiel	Aluminiumprofiel	extruded aluminium	en profilé d'aluminium
Voorzien van magneet	Mit Magnet ausgestattet	Equipped with a magnet	Équipé d'un aimant
Geschikt voor stalen kasten, deurkozijnen, koelkasten ed.	Nur für metallischen Untergrund geeignet.	Appropriate for attachment to closets, door-frames, refrigerators etc.	Appropriée d'être accroché aux armoires, chambranles de porte, réfrigérateurs etc.
Draagkracht: 6 kg	Haftkraft: 6 kg	The hook is disposed of a maximum capacity of 6 kg.	La patère dispose d'une portance maximum de 6 kg.
geanodiseerd -01 naturel	eloxiert -01 silber	anodized -01 silver	anodisé -01 argent
geëpoxideerd -18 zwart	pulverbeschichtet -18 schwarz	epoxy plastic coated -18 black	thermolaqué -18 noir

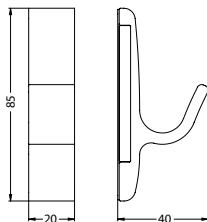

HOED- EN JASHAKEN



0200



0201

JASHAAK VOOR PLAFONDBEVESTIGING	MANTELHAKEN FÜR DECKENBEVESTIGUNG	COAT HOOK FOR CEILING MOUNTING	CROCHETS PORTECHAPEAU ET PORTEMANTEAU
aluminium	Aluminium	aluminium	aluminium
<p>0200 vast voor 2 jassen -01 naturel geanodiseerd -70 zwart geëpoxeerd</p>	<p>0200 fest für 2 Mäntel -01 silber eloxiert -70 schwarz pulverbeschichtet</p>	<p>0200 fixed for 2 coats -01 silver anodized -70 black epoxy plastic coated</p>	<p>0200 fixe pour 2 vestes -01 argent anodisé -70 noir thermolaqué</p>
<p>0201 draaibaar voor 4 jassen -01 naturel geanodiseerd -18 zwart geëpoxeerd</p>	<p>0201 drehbar für 4 Mäntel -01 silber eloxiert -18 schwarz pulverbeschichtet</p>	<p>0201 rotatable for 4 coats -01 silver anodized -18 black epoxy plastic coated</p>	<p>0201 tournant pour 4 vestes -01 argent anodisé -18 noir thermolaqué</p>

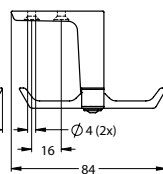
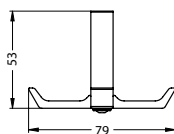
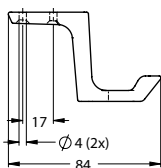
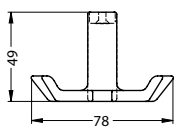

HOED- EN JASHAKEN



0202

JASHAAK MET BUFFER	MANTELHAKEN MIT PUFFER	BUFFERED COAT HOOK	CROCHET PORTEMANTEAU AVEC BUTOIR
van aluminium profiel	Aluminiumprofiel	extruded aluminium	en profilé d'aluminium
buffer van zwart rubber	Puffer aus schwarzem Gummi	black rubber buffer	butoir en caoutchouc noir
geanodiseerd -01 naturel	eloxiert -01 silber	anodized -01 silver	anodisé -01 argent

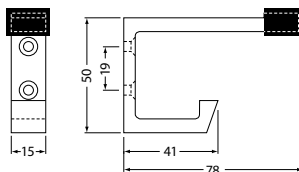

HOED- EN JASHAKEN

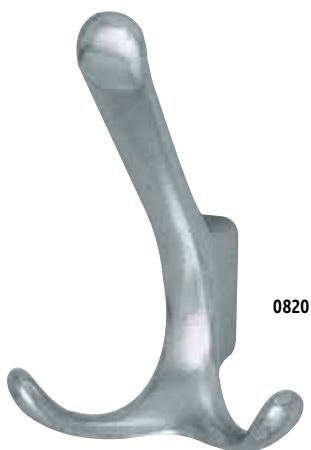

0820



0860

HOED- EN JASHAKEN	HUT- UND MANTELHAKEN	HAT AND COAT HOOKS	CROCHETS PORTECHAPEAU ET PORTEMANTEAU
gegoten aluminium	Aluminiumguss	cast aluminium	en fonte d'aluminium
geanodiseerd -01 naturel	eloxiert -01 silber	anodized -01 silver	anodisé -01 argent
met bevestigingsgaten 2 x M5	mit 2 x M5 Gewindebohrungen	with 2 x M5 threaded holes	avec 2 trous taraudés M5

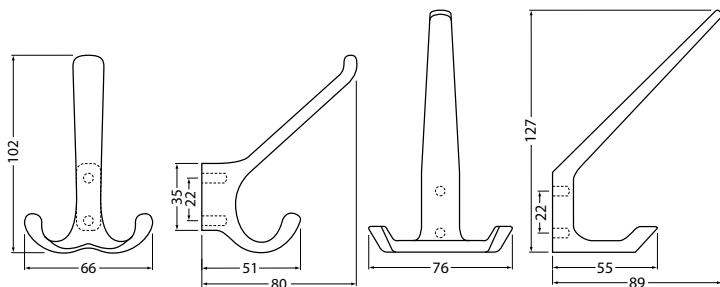

HOED- EN JASHAKEN



0880

HOED- EN JASHAKEN	HUT- UND MANTELHAKEN	HAT AND COAT HOOKS	CROCHETS PORTECHAPEAU ET PORTEMANTEAU
van aluminium profiel	Aluminiumprofil	extruded aluminium	en profilé d'aluminium
geanodiseerd -01 naturel	eloxiert -01 silber	anodized -01 silver	anodisé -01 argent
met bevestigingsgaten 2 x M5	mit 2 x M5 Gewindebohrungen	with 2 x M5 threaded holes	avec 2 trous taraudés M5

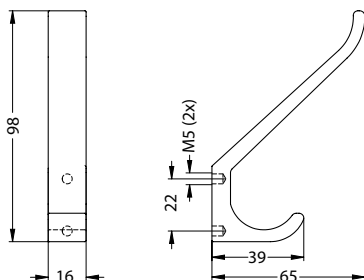

HANDDOEKHAKEN



HANDDOEKHAKEN	HANDTUCHHAKEN	TOWEL HOOKS	CROCHETS POUR ESSUIE-MAINS
gegoten aluminium	Aluminiumguss	cast aluminium	en fonte d'aluminium
geanodiseerd -01 naturel	eloxiert -01 silber	anodized -01 silver	anodisé -01 argent

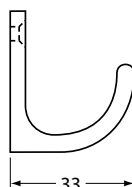
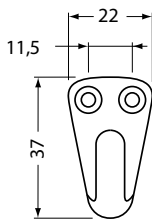
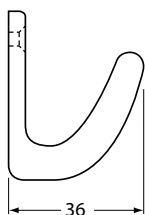
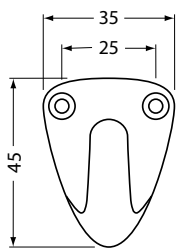

HANDDOEKHAKEN



0554



0555

HANDDOEKHAKEN	HANDTUCHHAKEN	TOWEL HOOKS	CROCHETS POUR ESSUIE-MAINS
van aluminium profiel	Aluminiumprofiel	extruded aluminium	en profilé d'aluminium
geanodiseerd -01 naturel	eloxiert -01 silber	anodized -01 silver	anodisé -01 argent
geëpoxideerd -18 zwart	pulverbeschichtet -18 schwarz	epoxy plastic coated -18 black	thermolaqué -18 noir

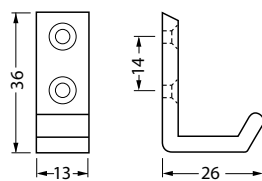
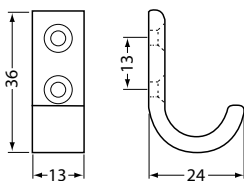

HANDDOEKHAKEN



0557



0559



0560



HANDDOEKHAKEN	HANDTUCHHAKEN	TOWEL HOOKS	CROCHETS POUR ESSUIE-MAINS
gegoten aluminium	Aluminiumguss	cast aluminium	en fonte d'aluminium
0557 -70 zwart geëpoxeerd -79 wit geëpoxeerd -93 gepolijst	0557 -70 schwarz kunststoff- beschichtet -79 weiß pulver- beschichtet -93 poliert	0557 -70 black epoxy plastic coated -79 white epoxy plastic coated -93 polished	0557 -70 noir thermolaqué -79 blanc thermolaqué -93 poli
0559 -79 wit geëpoxeerd -93 gepolijst	0559 -79 weiß pulver- beschichtet -93 poliert	0559 -79 white epoxy plastic coated -93 polished	0559 -79 blanc thermolaqué -93 poli
0560 -79 wit geëpoxeerd -93 gepolijst	0560 -79 weiß pulver- beschichtet -93 poliert	0560 -79 white epoxy plastic coated -93 polished	0560 -79 blanc thermolaqué -93 poli

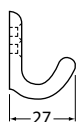
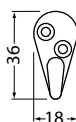
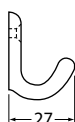

HANDDOEKREKJES

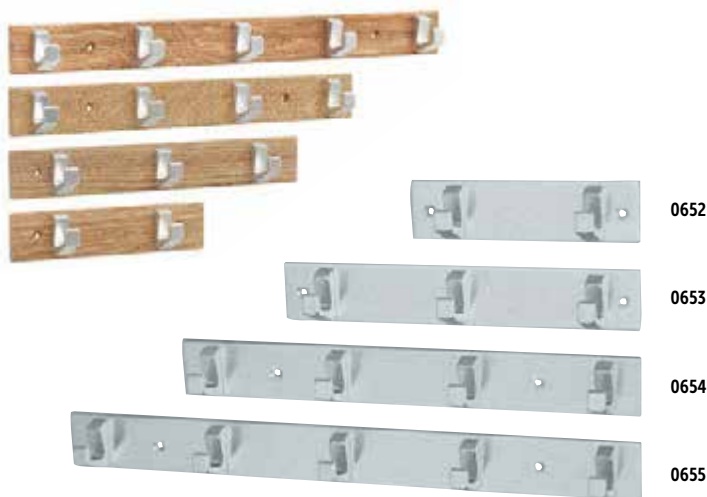

HANDDOEKREKJES	HANDTUCHLEISTEN	TOWEL HOOKS ON RAILS	PORTE-SERVIETTES
van aluminium profiel	Aluminiumprofiel	extruded aluminium	en profilé d'aluminium
geanodiseerd -01 naturel -11 mat naturel	eloxiert -01 silber -11 matt silber	anodized -01 silver -11 matt silver	anodisé -01 argent -11 argent mat
geëpoxeerd -79 wit	pulverbeschiktet -79 weiß	epoxy plastic coated -79 white	thermolaqué -79 blanc
met eikenhouten lijst en aluminium (-01) haken -36 eikenhout, geborsteld	mit Leiste aus Eichenholz und Aluminium (-01) Haken -36 Eichenholz, gebürstet	with oak rail and aluminium (-01) hooks -36 oak wood, brushed	avec bande en chêne et d'aluminium (-01) crochets -36 chêne, brossé

	A	L
0652	110 mm	130 mm
0653	190 mm	210 mm
0654	160 mm	280 mm
0655	240 mm	360 mm
0652-36	110 mm	150 mm
0653-36	190 mm	230 mm
0654-36	160 mm	280 mm
0655-36	240 mm	360 mm

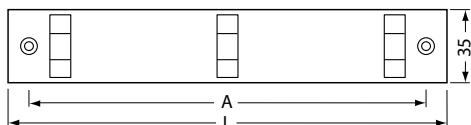
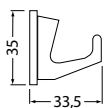

HAKENREKJES



0683



0685

HAKENREKJES	HAKENLEISTEN	COAT RACKS	SUPPORT À CROCHETS
van aluminium profiel	Aluminiumprofiel	extruded aluminium	en profilé d'aluminium
geanodiseerd -01 naturel	eloxiert -01 silber	anodized -01 silver	anodisé -01 argent

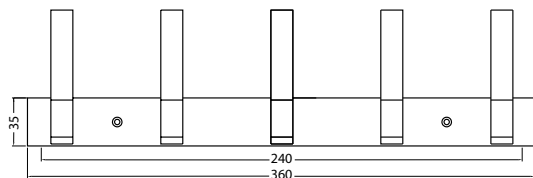
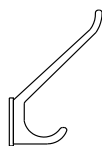
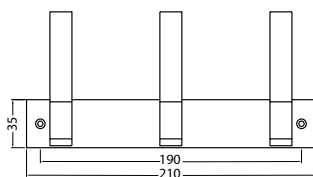
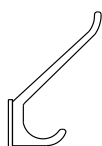

KASTROEDEBUIJS

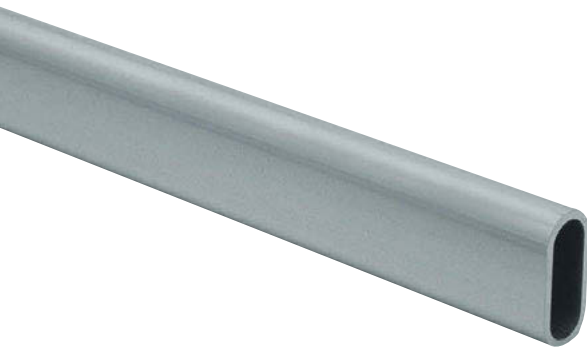

1900 - 1904 - 1905 - 1906 - 1907 - 1909

KASTROEDEBUIJS	SCHRANKROHRE	CUPBOARD TUBE	TUBES D'ARMOIRE
aluminium profiel	Aluminiumprofil	aluminium profile	en profilé d'aluminium
recht ovaal	flach oval	flat oval	ovale et aplatie
30 x 14 x 2 mm	30 x 14 x 2 mm	30 x 14 x 2 mm	30 x 14 x 2 mm
geanodiseerd -11 mat naturel	eloxiert -11 matt silber	anodized -11 matt silver	anodisé -11 argent mat
Garderobebuis zie pagina 98	Garderobenrohr siehe Seite 98	Wardrobe Tube see page 98	Tube vestiaire voir page 98

STEUNEN IN DE DAG	WANDLAGER FÜR SEITLICHE BEFESTIGUNG	END BRACKETS FOR SIDE WALL MOUNTING	SUPPORTS D'EXTRIMITES POUR FIXATION LATÉRALE
Zie pagina 99	Siehe Seite 99	See page 99	Voir page 99

	L
1905	1000 mm
1907	1500 mm
1904	2000 mm
1906	2500 mm
1909	3000 mm
1900	5000 mm

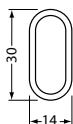

SCHUIFHAKEN



0591



1205

SCHUIFHAKEN	SCHIEBEHAKEN	SLIDING HOOKS	CROCHETS GLISSANT
van aluminium profiel	Aluminiumprofil	extruded aluminium	en profilé d'aluminium
0591 voor buis ø19 mm	0591 für Rohr ø19 mm	0591 for tube ø19 mm	0591 pour ø19 mm tube
geanodiseerd -01 naturel -11 mat naturel	eloxiert -01 silber -11 matt silber	anodized -01 silver -11 matt silver	anodisé -01 argent -11 argent mat
geëpoxideerd -18 zwart	pulverbeschichtet -18 schwarz	epoxy plastic coated -18 black	thermolaqué -18 noir
SCHUIFHAKEN	SCHIEBEHAKEN	SLIDING HOOKS	CROCHETS GLISSANT
van aluminium profiel	Leichtmetall	extruded aluminium	en profilé d'aluminium

1205
voor buis recht ovaal
30x14 en 30x15 mm

geanodiseerd
-01 naturel

geëpoxideerd
-18 zwart

1205
für Rohr flachoval
30x14 und 30x15 mm

eloxiert
-01 silber

pulverbeschichtet
-18 schwarz

1205
for tube flat oval
30x14 and 30x15 mm

anodized
-01 silver

epoxy plastic coated
-18 black

1205
pour ovale et aplatie
tube 30x14 et 30x15 mm

anodisé
-01 argent

thermolaqué
-18 noir

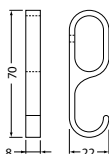
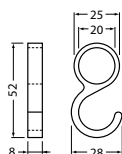

KAPSTOKGARNITUREN

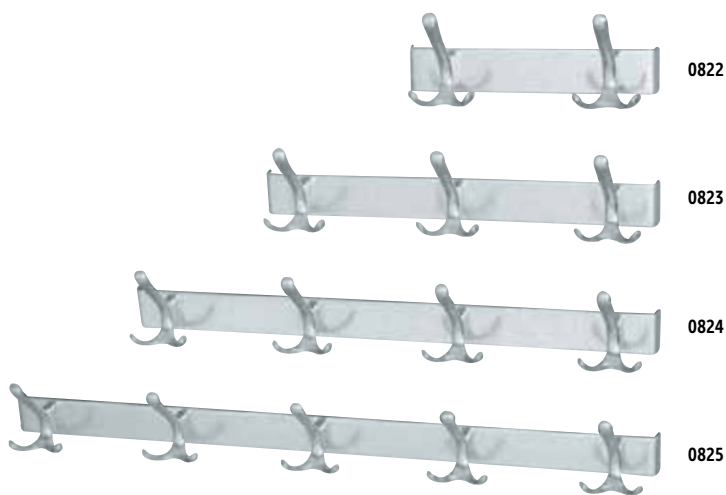

KAPSTOKGARNITUREN	GARDEROBENLEISTEN	COAT RACKS	PORTE-MANTEAUX
gegoten aluminium	Aluminiumguss	cast aluminium	en fonte d'aluminium
0822-0825 haken 0820 gemonteerd op garderobelijst	0822-0825 Haken 0820 montiert auf Profilleiste	0822-0825 hooks 0820 on back rail	0822-0825 patères 0820 , montées sur lice en aluminium
geanodiseerd -01 naturel	eloxiert -01 silber	anodized -01 silver	anodisé -01 argent

	L
0822	250 mm
0823	410 mm
0824	570 mm
0825	730 mm

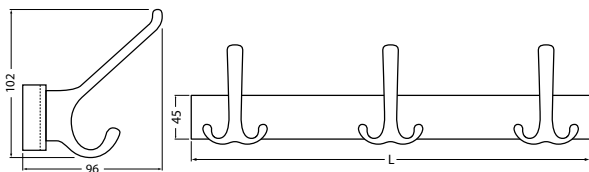

KAPSTOKGARNITUREN

0862



0863



0864



0865



KAPSTOKGARNITUREN	GÄRDEROBENLEISTEN	COAT RACKS	PORTE-MANTEAUX
gegoten aluminium	Aluminiumguss	cast aluminium	en fonte d'aluminium
0862-0865 haken 0860 gemonteerd op garderobelijst	0862-0865 Haken 0860 montiert auf Profilleiste	0862-0865 hooks 0860 on back rail	0862-0865 patères 0860 , montées sur lice en aluminium
geanodiseerd -01 naturel	eloxiert -01 silber	anodized -01 silver	anodisé -01 argent
0863 ook leverbaar in zwart	0863 auch in schwarz erhältlich	0863 also available in black	0863 également disponible en noir

	L
0862	250 mm
0863	410 mm
0864	570 mm
0865	730 mm

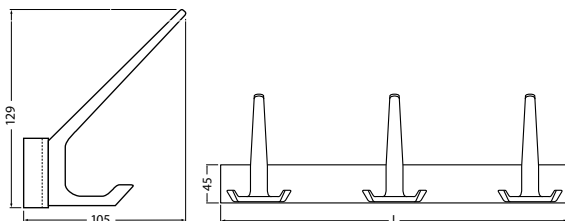

KAPSTOKGARNITUREN

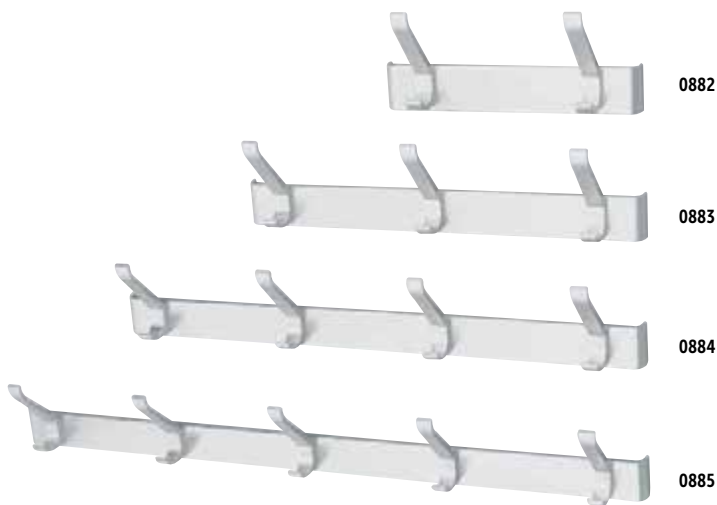

KAPSTOKGARNITUREN	GARDEROBENLEISTEN	COAT RACKS	PORTE-MANTEAUX
van aluminium profiel	Aluminiumprofiel	extruded aluminium	en profilé d'aluminium
0882-0885 haken 0880 gemonteerd op garderobelijst	0882-0885 Haken 0880 montiert auf Profilleiste	0882-0885 hooks 0880 on back rail	0882-0885 patères 0880 , montées sur lice en aluminium
geanodiseerd -01 naturel	eloxiert -01 silber	anodized -01 silver	anodisé -01 argent

	L
0882	250 mm
0883	410 mm
0884	570 mm
0885	730 mm

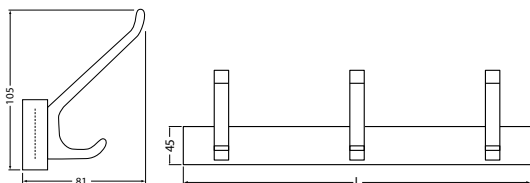

WANDGARDEROBE

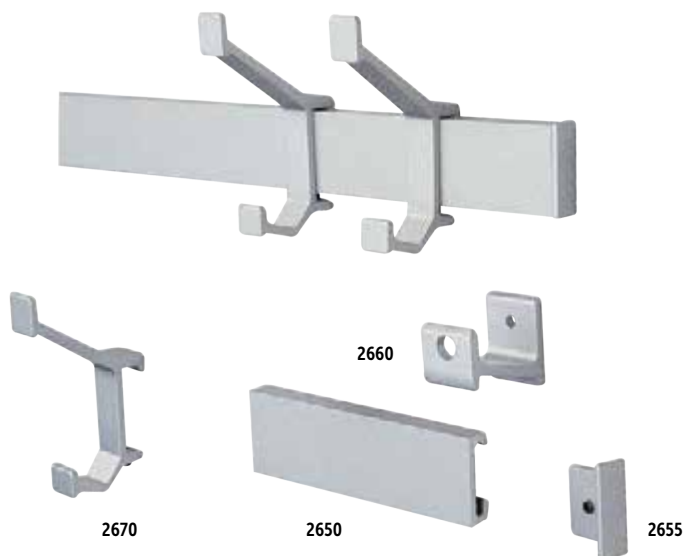

WANDGARDEROBE	WANDGARDEROBE	COAT RACK	PORTE-MANTEAU
van aluminium profiel	Aluminiumprofil	extruded aluminium	en profilé d'aluminium
bestaande uit: 2650 lijst 42 x 13mm leverlengte 5000 mm. 2660 steunen 2670 haken 2655 eindstops	zusammengestellt aus: 2650 Leiste 42 x 13mm Lieferlänge 5000 mm. 2660 Träger 2670 Haken 2655 Endkappen	consisting of: 2650 back rail 42 x 13mm standard length 5000 mm. 2660 brackets 2670 hooks 2655 end caps	composé de: 2650 profil 42 x 13mm longueur standard 5000 mm. 2660 supports 2670 crochets 2655 embouts
geanodiseerd -11 mat naturel	eloxiert -11 matt silber	anodized -11 matt silver	anodisé -11 argent mat

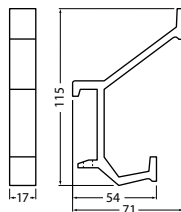
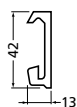
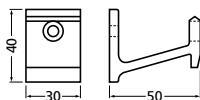
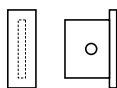

WANDGARDEROBE

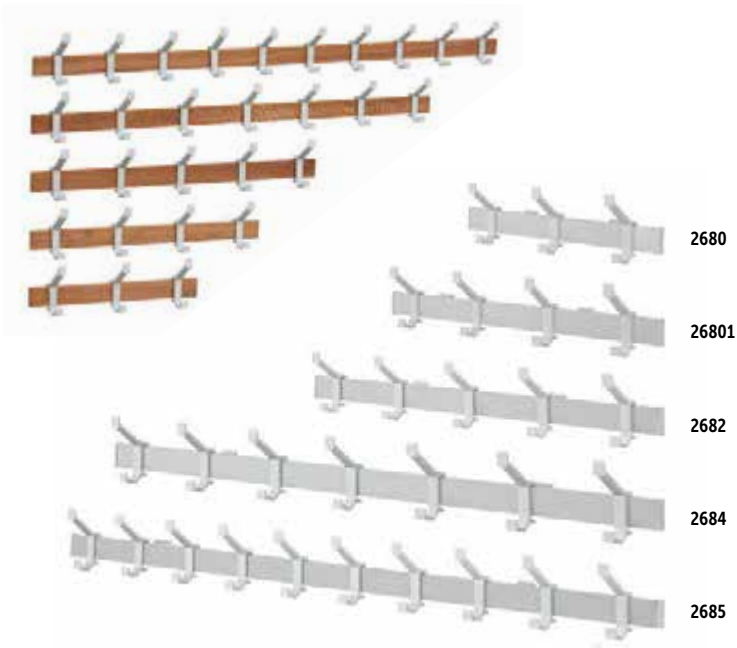

WANDGARDEROBE	WANDGARDEROBE	COAT RACK	PORTE-MANTEAU
2680 met 3 haken	2680 mit 3 Haken	2680 with 3 hooks	2680 avec 3 crochets
2681 met 4 haken	2681 mit 4 Haken	2681 with 4 hooks	2681 avec 4 crochets
2682 met 5 haken	2682 mit 5 Haken	2682 with 5 hooks	2682 avec 5 crochets
2684 met 7 haken	2684 mit 7 Haken	2684 with 7 hooks	2684 avec 7 crochets
2685 met 10 haken	2685 mit 10 Haken	2685 with 10 hooks	2685 avec 10 crochets
-11 mat naturel geanodiseerd -36 eikenhouten lijst, geborsteld en aluminium (-11) haken	-11 matt silber eloxiert -36 Leiste aus Eichenholz, gebürstet und Aluminium (-11) Haken	-11 matt silver anodized -36 oak wood rail, brushed and aluminium (-11) hooks	-11 argent mat -36 bande en chêne, brossé et d'aluminium (-11) crochets

	L (-11)	L (-36)
2680	410 mm	400 mm
2681	570 mm	560 mm
2682	730 mm	720 mm
2684	1050 mm	1040 mm
2685	1250 mm	1240 mm

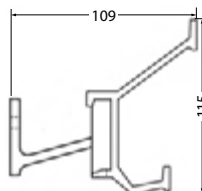
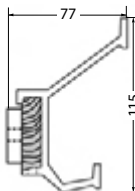



2 Leuninghouders

2 Handlaufstützen

2 Handrail brackets

2 Supports de main courante



LEUNINGHOUDERS



3500



3501



LEUNINGHOUDER	HANDLAUFSTÜTZE	HANDRAIL BRACKET	SUPPORT DE MAIN COURANTE
gegoten aluminium	Aluminiumguss	cast aluminium	en fonte d'aluminium
65 mm	65 mm	65 mm	65 mm
3500 holzadel, opschroevend 3501 holzadel, tapgat M8	3500 gewölbte Auflage, 3 Bohrungen 3501 gewölbte Auflage, Gewindebohrung M8	3500 radiused saddle, 3 fixing holes 3501 radiused saddle, M8 threaded hole	3500 concave, 3 trous de montage 3501 concave, avec trou taraudé M8
geanodiseerd -01 naturel	eloxiert -01 silber	anodized -01 silver	anodisé -01 argent
geëpoxeerd -70 zwart -79 wit	pulverbeschichtet -70 schwarz -79 weiß	epoxy plastic coated -70 black -79 white	thermolaqué -70 noir -79 blanc

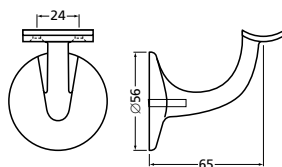
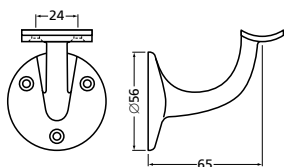

LEUNINGHOUDERS



3502



3503



LEUNINGHOUDER	HANDBLAUFSTÜTZE	HANDRAIL BRACKET	SUPPORT DE MAIN COURANTE
gegoten aluminium	Aluminiumguss	cast aluminium	en fonte d'aluminium
65 mm	65 mm	65 mm	65 mm
3502 vlakzadel, opschroevend 3503 vlakzadel, tapgat M8	3502 gerade Auflage, 3 Bohrungen 3503 gerade Auflage, Gewindebohrung M8	3502 flat saddle, 3 fixing holes 3503 flat saddle, M8 threaded hole	3502 plat, 3 trous de montage 3503 plat, trou taraudé M8
geanodiseerd -01 naturel	eloxiert -01 silber	anodized -01 silver	anodisé -01 argent
geëpoxeerd -70 zwart -79 wit	pulverbeschichtet -70 schwarz -79 weiß	epoxy plastic coated -70 black -79 white	thermolaqué -70 noir -79 blanc

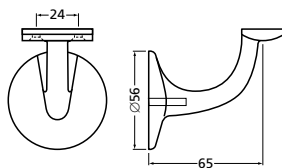
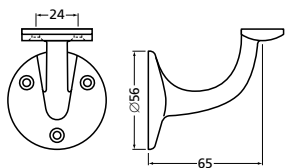

LEUNINGHOUDERS

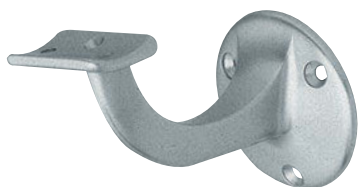

3505



3506

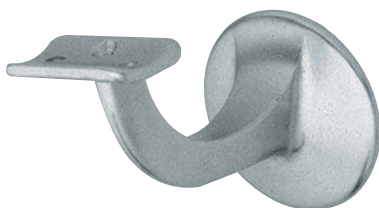

LEUNINGHOUDER	HANDBLAUFSTÜTZE	HANDRAIL BRACKET	SUPPORT DE MAIN COURANTE
gegoten aluminium	Aluminiumguss	cast aluminium	en fonte d'aluminium
75 mm	75 mm	75 mm	75 mm
3505 holzadel, opschroevend 3506 holzadel, tapgat M8	3505 gewölbte Auflage, 3 Bohrungen 3506 gewölbte Auflage, Gewindebohrung M8	3505 radiused saddle, 3 fixing holes 3506 radiused saddle, M8 threaded hole	3505 concave, 3 trous de montage 3506 concave, avec trou taraudé M8
geanodiseerd -01 naturel	eloxiert -01 silber	anodized -01 silver	anodisé -01 argent
geëpoxeerd -70 zwart	pulverbeschichtet -70 schwarz	epoxy plastic coated -70 black	thermolaqué -70 noir

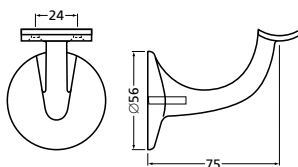
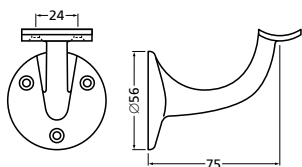

LEUNINGHOUDERS



3507



3508

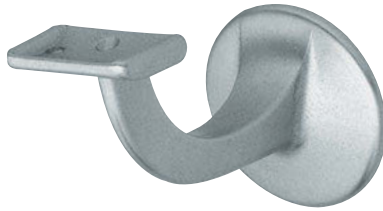

LEUNINGHOUDER	HANDBLAUFSTÜTZE	HANDRAIL BRACKET	SUPPORT DE MAIN COURANTE
gegoten aluminium	Aluminiumguss	cast aluminium	en fonte d'aluminium
75 mm	75 mm	75 mm	75 mm
3507 vlakzadel, opschroevend 3508 vlakzadel, tapgat M8	3507 gerade Auflage, 3 Bohrungen 3508 gerade Auflage, Gewindebohrung M8	3507 flat saddle, 3 fixing holes 3508 flat saddle, M8 threaded hole	3507 plat, 3 trous de montage 3508 plat, trou taraudé M8
geanodiseerd -01 naturel	eloxiert -01 silber	anodized -01 silver	anodisé -01 argent
geëpoxeerd -70 zwart	pulverbeschichtet -70 schwarz	epoxy plastic coated -70 black	thermolaqué -70 noir

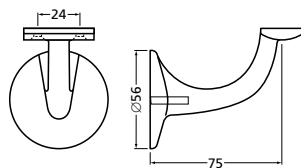
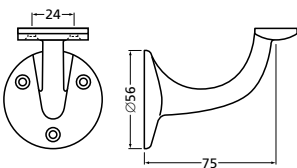

SAMENGESTELDE LEUNINGHOUDERS

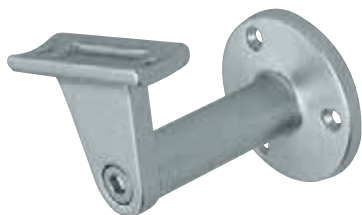

3510

3515



LEUNINGHOUDER	HANDBLAUFSTÜTZE	HANDRAIL BRACKET	SUPPORT DE MAIN COURANTE
gegoten aluminium	Aluminiumguss	cast aluminium	en fonte d'aluminium
75 mm	75 mm	75 mm	75 mm
3510 holzadel, opschroevend 3515 holzadel, tappgat M8	3510 gewölbte Auflage, 3 Bohrungen 3515 gewölbte Auflage, Gewindebohrung M8	3510 radiused saddle, 3 fixing holes 3515 radiused saddle, M8 threaded hole	3510 concave, 3 trous de montage 3515 concave, trou taraudé M8
geanodiseerd -01 naturel	eloxiert -01 silber	anodized -01 silver	anodisé -01 argent

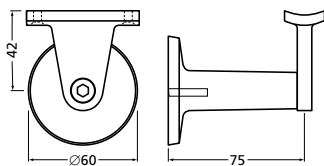
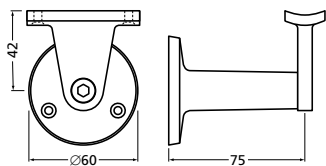

SAMENGESTELDE LEUNINGHOUDERS

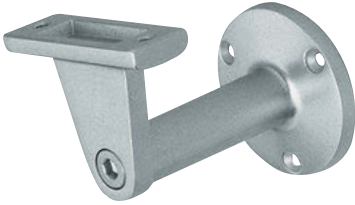

3520

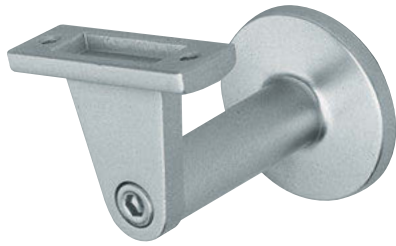

3525

LEUNINGHOUDER	HANDBLAUFSTÜTZE	HANDRAIL BRACKET	SUPPORT DE MAIN COURANTE
gegoten aluminium	Aluminiumguss	cast aluminium	en fonte d'aluminium
75 mm	75 mm	75 mm	75 mm
3520 vlakzadel, opschroevend 3525 vlakzadel, tapgat M8	3520 gerade Auflage, 3 Bohrungen 3525 gerade Auflage, Gewindebohrung M8	3520 flat saddle, 3 fixing holes 3525 flat saddle, M8 threaded hole	3520 plat, 3 trous de montage 3525 plat, trou taraudé M8
geanodiseerd -01 naturel	eloxiert -01 silber	anodized -01 silver	anodisé -01 argent

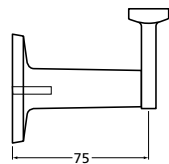
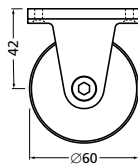
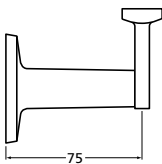
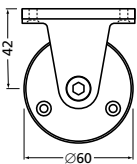

LEUNINGHOUDERS



3540



3541

LEUNINGHOUDER	HANDBLAUFSTÜTZE	HANDRAIL BRACKET	SUPPORT DE MAIN COURANTE
van aluminium profiel	Aluminiumprofiel	extruded aluminium	en profilé d'aluminium
65 mm	65 mm	65 mm	65 mm
3540 vlakzadel, opschroevend 3541 vlakzadel, met gat voor stokschroef M8	3540 gerade Auflage, zum Aufschrauben 3541 gerade Auflage, mit Loch für M8-Schraube	3540 flat saddle, for screw fixing 3541 flat saddle, with single hole for M8 fixing bolt	3540 plat, pour fixation au mur par vis 3541 plat, avec trou pour boulon M8
(stokschroef en dopmoer zie pag. 83 en 84)	(Stockschraube und Hutmutter siehe Seiten 83 und 84)	(threaded screw and dome headed nut, see pages 83 and 84)	(vis captive et écrou borgne voir pages 83 et 84)
geanodiseerd -01 naturel -11 mat naturel	eloxiert -01 silber -11 matt silber	anodized -01 silver -11 matt silver	anodisé -01 argent -11 argent mat
geëpoxideerd -18 zwart	pulverbeschichtet -18 schwarz	epoxy plastic coated -18 black	thermolaqué -18 noir

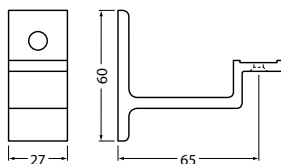
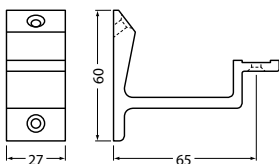

LEUNINGHOUDERS

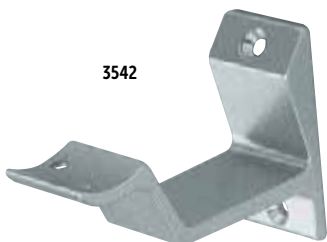

3542



3543

LEUNINGHOUDER	HANDBLAUFSTÜTZE	HANDRAIL BRACKET	SUPPORT DE MAIN COURANTE
van aluminium profiel	Aluminiumprofil	extruded aluminium	en profilé d'aluminium
65 mm	65 mm	65 mm	65 mm
3542 holzadel, opschroevend 3543 holzadel, met gat voor stokschroef M8	3542 gewölbte Auflage, zum Aufschrauben 3543 gewölbte Auflage, mit Loch für M8-Schraube	3542 radiused saddle, for screw fixing 3543 radiused saddle, with single hole for M8 fixing bolt	3542 concave, pour fixation au mur par vis 3543 concave, avec trou pour boulon M8
(stokschroef en dopmoer zie pag. 83 en 84)	(Stockschraube und Hutmutter siehe Seiten 83 und 84)	(threaded screw and dome headed nut, see pages 83 and 84)	(vis captive et écrou borgne voir pages 83 et 84)
geanodiseerd -01 naturel -11 mat naturel	eloxiert -01 silber -11 matt silber	anodized -01 silver -11 matt silver	anodisé -01 argent -11 argent mat
geëpoxeerd -18 zwart	pulverbeschichtet -18 schwarz	epoxy plastic coated -18 black	thermolaqué -18 noir

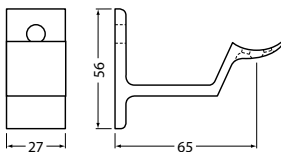
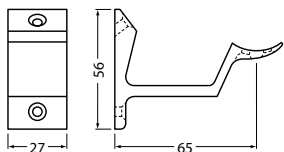

LEUNINGHOUDERS



3550



3551

LEUNINGHOUDER	HANDLAUFSTÜTZE	HANDRAIL BRACKET	SUPPORT DE MAIN COURANTE
van aluminium profiel	Aluminiumprofiel	extruded aluminium	en profilé d'aluminium
76 mm	76 mm	76 mm	76 mm
3550 vlakzadel, opschroevend 3551 vlakzadel, met gat voor stokschroef M8	3550 gerade Auflage, zum Aufschrauben 3551 gerade Auflage, mit Loch für M8-Schraube	3550 flat saddle, for screw fixing 3551 flat saddle, with single hole for M8 fixing bolt	3550 plat, pour fixation au mur par vis 3551 plat, avec trou pour boulon M8
(stokschroef en dopmoer zie pag. 83 en 84)	(Stockschraube und Hutmutter siehe Seiten 83 und 84)	(threaded screw and dome headed nut, see pages 83 and 84)	(vis captive et écrou borgne voir pages 83 et 84)
geanodiseerd -01 naturel -11 mat naturel	eloxiert -01 silber -11 matt silber	anodized -01 silver -11 matt silver	anodisé -01 argent -11 argent mat
geëpoxeerd -18 zwart	pulverbeschichtet -18 schwarz	epoxy plastic coated -18 black	thermolaqué -18 noir

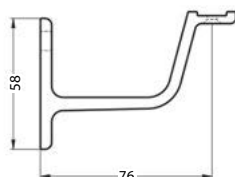
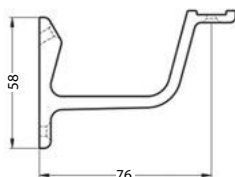

LEUNINGHOUDERS



3552



3553

LEUNINGHOUDER	HANDBLAUFSTÜTZE	HANDRAIL BRACKET	SUPPORT DE MAIN COURANTE
van aluminium profiel	Aluminiumprofiel	extruded aluminium	en profilé d'aluminium
76 mm	76 mm	76 mm	76 mm
3552 holzadel, opschroevend 3553 holzadel, met gat voor stokschroef M8	3552 gewölbte Auflage, zum Aufschrauben 3553 gewölbte Auflage, mit Loch für M8-Schraube	3552 radiused saddle, forscrew fixing 3553 radiused saddle, with single hole for M8 fixing bolt	3552 concave, pour fixation au mur par vis 3553 concave, avec trou pour boulon M8
(stokschroef en dopmoer zie pag. 83 en 84)	(Stockschraube und Hutmutter siehe Seiten 83 und 84)	(threaded screw and dome headed nut, see pages 83 and 84)	(vis captive et écrou borgne voir ages 83 et 84)
geanodiseerd -01 naturel -11 mat naturel	eloxiert -01 silber -11 matt silber	anodized -01 silver -11 matt silver	anodisé -01 argent -11 argent mat
geëpoxeerd -18 zwart	pulverbeschichtet -18 schwarz	epoxy plastic coated -18 black	thermolaqué -18 noir

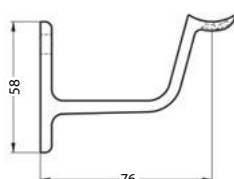
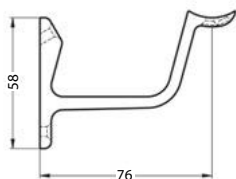

VERSTELBARE AFSTANDHOUDERS

3580



3581



AFSTANDHOUDER, VERSTELBAAR	ABSTANDHALTER, VERSTELLBAR	ADJUSTABLE BRACKET	SUPPORT, REGLABLE
van aluminium profiel	Aluminiumprofil	extruded aluminium	en profilé d'aluminium
<p>3580 instelbaar tussen 44 en 56 mm</p> <p>3581 instelbaar tussen 55 en 76 mm</p> <p>geanodiseerd -11 mat naturel</p>	<p>3580 verstelbaar zwischen 44 bis 56 mm</p> <p>3581 verstelbaar zwischen 55 bis 76 mm</p> <p>eloxiert -11 matt silber</p>	<p>3580 adjustable between 44 and 56 mm</p> <p>3581 adjustable between 55 and 76 mm</p> <p>anodized -11 matt silver</p>	<p>3580 réglable entre 44 et 56 mm</p> <p>3581 réglable entre 55 et 76 mm</p> <p>anodisé -11 argent mat</p>

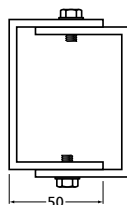
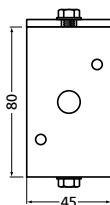
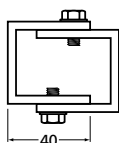
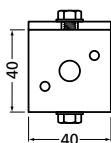





3 Grepen en meubelknoppen

3 Griffe und Möbelknöpfe

3 Pull handles and cupboard knobs

3 Poignées et boutons de meuble



MEUBELKNOPPEN



3731



3732

MEUBELKNOPPEN	MÖBELKNÖPFE	CUPBOARD KNOBS	BOUTONS DE MEUBLE
van aluminium profiel	Aluminiumprofil	extruded aluminium	en profilé d'aluminium
cilindermodel met tapgat M4	zylindrisch mit Gewindebohrung M4	cylindrical with M4 threaded hole	cylindrique avec trou taraudé M4
geanodiseerd -11 mat naturel	eloxiert -11 matt silber	anodized -11 matt silver	anodisé -11 argent mat
geëpoxeerd -70 zwart	pulverbeschichtet -70 schwarz	epoxy plastic coated -70 black	thermolaqué -70 noir

	A	B
3731	20 mm	23 mm
3732	25 mm	26 mm

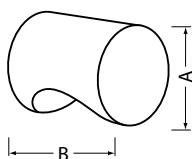

MEUBELKNOPPEN



3751



3752



3753

MEUBELKNOPPEN	MÖBELKNÖPFE	CUPBOARD KNOBS	BOUTONS DE MEUBLE
van aluminium profiel	Aluminiumprofiel	extruded aluminium	en profilé d'aluminium
met taggat M4	mit Gewindebohrung M4	with M4 threaded hole	avec trou taraudé M4
geanodiseerd -01 naturel	eloxiert -01 silber	anodized -01 silver	anodisé -01 argent
geëpoxeerd -70 zwart -79 wit	pulverbeschikt -70 schwarz -79 weiß	epoxy plastic coated -70 black -79 white	thermolaqué -70 noir -79 blanc

	A	B
3751	30 mm	20 mm
3752	35 mm	21 mm
3753	40 mm	22 mm

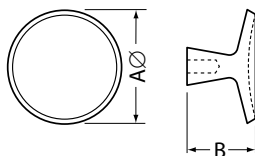

MEUBELKNOPPEN



3755



MEUBELKNOP XL	MÖBELKNÖPF XL	CUPBOARD KNOB XL	BOUTON DE MEUBLE XL
van aluminium profiel	Aluminiumprofil	extruded aluminium	en profilé d'aluminium
met tapgat M4	mit Gewindebohrung M4	with M4 threaded hole	avec trou taraudé M4
geanodiseerd -01 naturel -11 mat naturel	eloxiert -01 silber -11 matt silber	anodized -01 silver -11 matt silver	anodisé -01 argent -11 argent mat
geëpoxeerd -70 zwart	pulverbeschichtet -70 schwarz	epoxy plastic coated -70 black	thermolaqué -70 noir

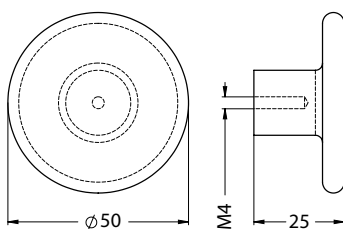

LADEGREPEN



4087



4089

LADEGREPEN	MÖBELGRIFFE	CABINET HANDLES	POIGNEES DE MEUBLE
van aluminium profiel	Aluminiumprofiel	extruded aluminium	en profilé d'aluminium
geanodiseerd -01 naturel -11 mat naturel	eloxiert -01 silber -11 matt silber	anodized -01 silver -11 matt silver	anodisé -01 argent -11 argent mat
geëpoxideerd -18 zwart	pulverbeschiktet -18 schwarz	epoxy plastic coated -18 black	thermolaqué -18 noir

	A	B
4087	70 mm	58 mm
4088	90 mm	78 mm

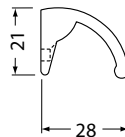
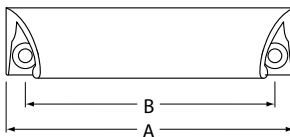

LADEGREPEN



4192



4193

LADEGREPEN	MÖBELGRIFFE	CABINET HANDLES	POIGNEES DE MEUBLE
van aluminium profiel	Aluminiumprofiel	extruded aluminium	en profilé d'aluminium
met tapgat M5	mit Gewindebohrung M5	with M5 threaded hole	avec trou taraudé M5
geanodiseerd -01 naturel -11 mat naturel	eloxiert -01 silber -11 matt silber	anodized -01 silver -11 matt silver	anodisé -01 argent -11 argent mat
geëpoxeerd -18 zwart	pulverbeschichtet -18 schwarz	epoxy plastic coated -18 black	thermolaqué -18 noir

	A	B	C	D
4192	108 mm	88 mm	25 mm	12 mm
4193	130 mm	110 mm	29 mm	13 mm

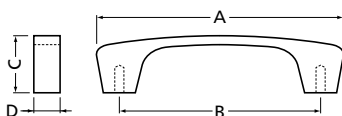

HANDGREPEN

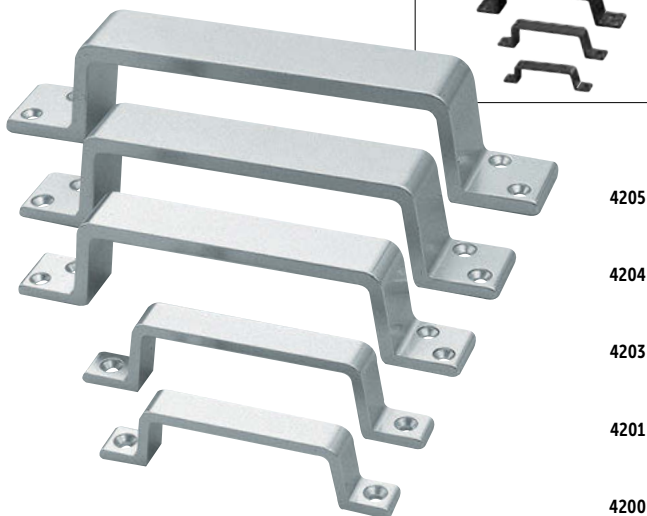

4205

4204

4203

4201

4200

GREPEN	GRIFFE	HANDLES	POIGNEES
van aluminium profiel	Aluminiumprofiel	extruded aluminium	en profilé d'aluminium
geanodiseerd -01 naturel -11 mat naturel	eloxiert -01 silber -11 matt silber	anodized -01 silver -11 matt silver	anodisé -01 argent -11 argent mat
geëpoxideerd -18 zwart -79 wit	pulverbeschichted -18 schwarz -79 weiß	epoxy plastic coated -18 black -79 white	thermolaqué -18 noir -79 blanc

	A	B	C	C1	C2	D	E
4200	90 mm	18 mm	78 mm			12 mm	
4201	110 mm	23 mm	95 mm			13 mm	
4203	150 mm	28 mm		120,5 mm	137,5 mm	20,5 mm	9,5 mm
4204	170 mm	32 mm		138 mm	155,5 mm	25 mm	13 mm
4205	200 mm	35 mm		162 mm	183,5 mm	29 mm	16 mm

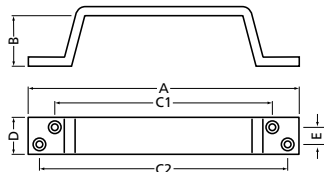
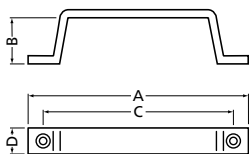

HANDGREPEN



GREPEN	GRIFFE	HANDLES	POIGNEES
van aluminium profiel	Aluminiumprofiel	extruded aluminium	en profilé d'aluminium
geanodiseerd -01 naturel -11 mat naturel	eloxiert -01 silber -11 matt silber	anodized -01 silver -11 matt silver	anodisé -01 argent -11 argent mat
geëpoxideerd -18 zwart	pulverbeschichtet -18 schwarz	epoxy plastic coated -18 black	thermolaqué -18 noir

	A	B	C	D
4231	112 mm	21 mm	96 mm	14 mm
4232	149 mm	28 mm	128 mm	19 mm
4233	186 mm	35 mm	160 mm	24 mm

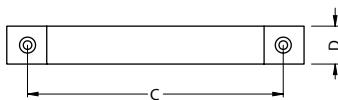

HANDGREPEN



GREPEN	GRIFFE	HANDLES	POIGNEES
gegoten aluminium	Aluminiumguss	cast aluminium	en fonte d'aluminium
geanodiseerd -01 naturel	eloxiert -01 silber	anodized -01 silver	anodisé -01 argent

	A	B	C	D	E
4255	110 mm	22 mm	95 mm	36 mm	24 mm
4256	140 mm	26 mm	125 mm	38 mm	26 mm
4257	160 mm	30 mm	138 mm	42 mm	30 mm
4258	190 mm	33 mm	168 mm	47 mm	34 mm

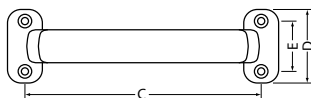
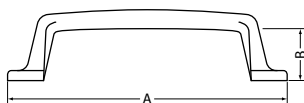

HANDGREPEN



4270



4268



4265

GREPEN	GRIFFE	HANDLES	POIGNEES
gegoten aluminium	Aluminiumguss	cast aluminium	en fonte d'aluminium
geanodiseerd -01 naturel	eloxiert -01 silber	anodized -01 silver	anodisé -01 argent
geëpoxideerd -70 zwart -79 wit	pulverbeschichtet -70 schwarz -79 weiß	epoxy plastic coated -70 black -79 white	thermolaqué -70 noir -79 blanc

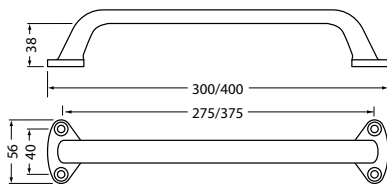
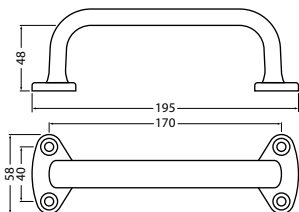

RAAMLICHTERS EN -PENNEN

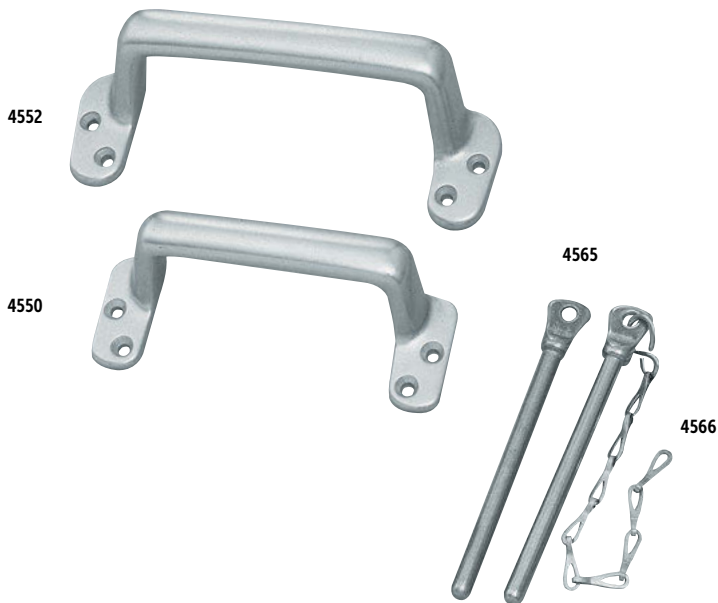

RAAMLICHTERS	GRIFFE FÜR SCHIEBE-FENSTER	HANDLES FOR LIFT-UP WINDOWS	POIGNEES POUR FENETRES À GUILLOTINE
gegoten aluminium	Aluminiumguss	cast aluminium	en fonte d'aluminium
geanodiseerd -01 naturel	eloxiert -01 silber	anodized -01 silver	anodisé -01 argent
RAAMPEN	FENSTERSICHERUNG	SASH PIN	GOUPILLE
gegoten aluminium	Aluminiumguss	cast aluminium	en fonte d'aluminium
-96 blank	-96 roh	-96 unfinished	-96 brut
4565 zonder ketting	4565 ohne Kette	4565 without chain	4565 sans chaine
4566 met ketting	4566 mit Kette	4566 with chain	4566 avec chaine

	A	B	C	D	E
4550	110 mm	89 mm	100 mm	31 mm	12 mm
4552	136 mm	106 mm	124 mm	35 mm	12 mm

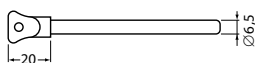
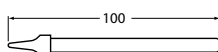
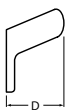
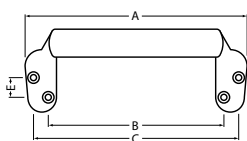



4 Schuifdeurkommen

4 Muschelgriffe

4 Flush pull

4 Poignee cuvette



SCHUIFDEURKOMMEN



4554



4555



SCHUIFDEURKOM	MUSCHELGRIFFE FÜR SCHIEBETÜR	FLUSH PULL	POIGNEE CUVETTE POUR PORTE COULISSANTE
aluminium profiel	Aluminiumprofil	extruded aluminium	en profilé d'aluminium
rond model	rundes Modell	round model	modèle rond
geanodiseerd -01 naturel	eloxiert -01 silber	anodized -01 silver	anodisé -01 argent
geëpoxeerd -70 zwart	pulverbeschichtet -70 schwarz	epoxy plastic coated -70 black	thermolaqué -70 noir

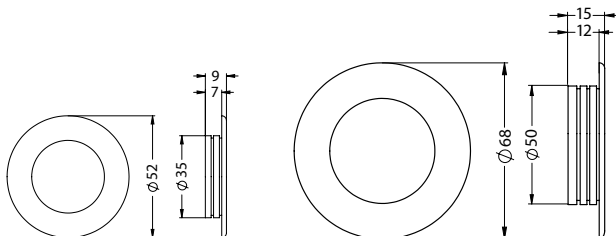

SCHUIFDEURKOMMEN

4556



4558



SCHUIFDEURKOM	MUSCHELGRIFFE FÜR SCHIEBETÜR	FLUSH PULL	POIGNEE CUVETTE POUR PORTE COULISSANTE
aluminium profiel	Aluminiumprofil	extruded aluminium	en profilé d'aluminium
rechthoekig model	rechteckigen Modell	rectangular model	modèle rectangulaire
geanodiseerd -01 naturel	eloxiert -01 silber	anodized -01 silver	anodisé -01 argent
geëpoxideerd -70 zwart	pulverbeschichted -70 schwarz	epoxy plastic coated -70 black	thermolaqué -70 noir

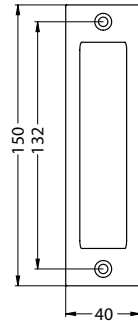
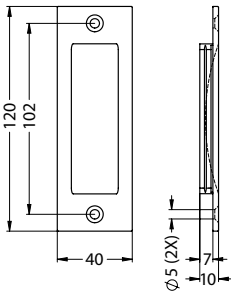

SCHUIFDEURKOMMEN

4560



4562



SCHUIFDEURKOM	MUSCHELGRIFFE FÜR SCHIEBETÜR	FLUSH PULL	POIGNEE CUVETTE POUR PORTE COULISSANTE
aluminium profiel	Aluminiumprofil	extruded aluminium	en profilé d'aluminium
ovaal model	oval Modell	oval model	modèle ovale
geanodiseerd -01 naturel	eloxiert -01 silber	anodized -01 silver	anodisé -01 argent
geëpoxideerd -70 zwart	pulverbeschichtet -70 schwarz	epoxy plastic coated -70 black	thermolaqué -70 noir

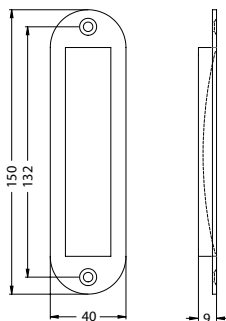
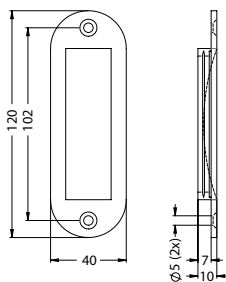





5 Deurbuffers en deurduwers

5 Türpuffer und Türgriffe

5 Door checks and push pads

**5 Arrets de porte
et poignees de porte**



DEURBUFFERS



4709

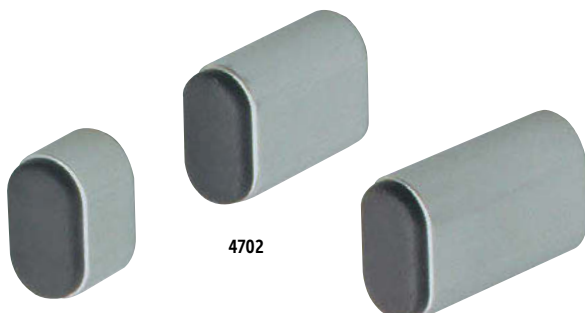

4700

4702

4704

DEURBUFFERS	TÜRPUFFER	DOORCHECKS	ARRÊTS DE PORTE
van aluminium profiel	Aluminiumprofil	extruded aluminium	en profilé d'aluminium
met buffer van zacht kunststof, zwart onzichtbare bevestiging 4700 - L = 25 mm 4702 - L = 50 mm 4704 - L = 60 mm	mit Puffer von Kunststoff, weich, schwarz Befestigung verdeckt 4700 - L = 25 mm 4702 - L = 50 mm 4704 - L = 60 mm	with soft plastic buffer, black invisible mounting 4700 - L = 25 mm 4702 - L = 50 mm 4704 - L = 60 mm	avec butoir en matière synthétique, tendre, noir fixation cachée 4700 - L = 25 mm 4702 - L = 50 mm 4704 - L = 60 mm
geanodiseerd -01 naturel -11 mat naturel	eloxiert -01 silber -11 matt silber	anodized -01 silver -11 matt silver	anodisé -01 argent -11 argent mat
geëpoxideerd -18 zwart	pulverbeschichtet -18 schwarz	epoxy plastic coated -18 black	thermolaqué -18 noir
LOSSE BUFFER	LOSE PUFFER	LOOSE BUFFER	BUTOIR VRAC
4709-80 zwart	4709-80 schwarz	4709-80 black	4709-80 noir

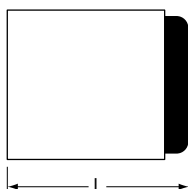
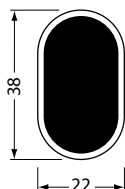

DEURBUFFERS



4735

DEURBUFFERS	TÜRPUFFER	DOORCHECKS	ARRÊTS DE PORTE
van aluminium profiel	Aluminiumprofiel	extruded aluminium	en profilé d'aluminium
met buffer van zacht kunststof, zwart met taggat M8	mit Puffer von Kunststoff, weich, schwarz Gewindebohrung M8	with soft plastic buffer, black M8 threaded hole	avec boutoir en matière synthétique, tendre, noir trou taraudé M8
geanodiseerd -11 mat naturel	eloxiert -11 matt silber	anodized -11 matt silver	anodisé -11 argent mat
geëpoxideerd -18 zwart	pulverbeschichtet -18 schwarz	epoxy plastic coated -18 black	thermolaqué -18 noir

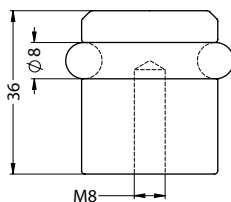
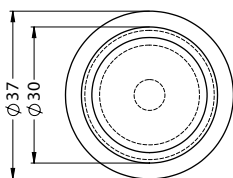

DEURBUFFERS

4760



DEURBUFFERS	TÜRPUFFER	DOORCHECKS	ARRÊTS DE PORTE
van aluminium profiel	Aluminiumprofil	extruded aluminium	en profilé d'aluminium,
vloermodel, ø 60 mm met zacht kunststof ring	Bodenmodell, ø 60 mm mit kunststoff Ring	floormounting, ø 60 mm with soft plastic ring	montage sur le sol, ø 60 mm anneau matière synthétique
geanodiseerd -11 mat naturel	eloxiert -11 matt silber	anodized -11 matt silver	anodisé -11 argent mat

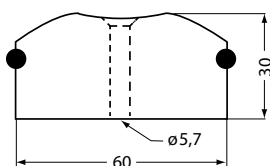

DEURDUWERS



4321

DEURDUWERS	TÜRGRIFFE	PUSH PADS	BOUTONS DE PORT
van aluminium profiel	Aluminiumprofil	extruded aluminium	en profilé d'aluminium
met 2 x gat Ø 8,5 mm als stel te gebruiken	mit 2 x Bohrungen Ø 8,5 mm als Paar zu benutzen	with 2 x holes Ø 8,5 mm for back to back pair fixing	avec 2 trous Ø 8,5 mm utiliser par paire
geanodiseerd -01 naturel	eloxiert -01 silber	anodized -01 silver	anodisé -01 argent

	B	L
4321	120 mm	150 mm

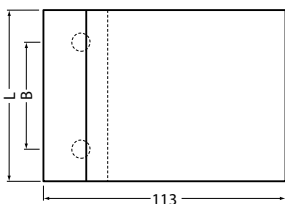
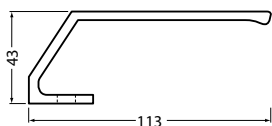



6 Doorvalbeveiliging

6 Durchsturzsicherung

6 Fall protection

6 Barre de protection



HERMETA DOORVALBEVEILIGING

“VAST EN ZEKER”

Een doorvalbeveiliging voorkomt dat mensen uit het raam kunnen vallen. Deze doorvalbeveiliging, gemaakt van aluminium, is gecertificeerd volgens de Europese norm NEN-EN 1991.1.1. Dat betekent o.a. dat het een stootbelasting op kan vangen met een kinetische energie van 0,5 kNm. Er zijn middensteunen nodig als de overspanning tussen twee steunen te groot wordt.

De doorvalbeveiliging is geschikt voor nieuwbouw en bestaande woningen of gebouwen, binnen- en buitengebruik en zowel in de dag als op de dag toe te passen. De aluminium koker profielen (rond of vierkant) kunnen op standaardlengtes of speciaal op maat geleverd worden. De artikelen worden standaard geleverd in mat naturel geanodiseerd (kleur 11) of met een poedercoating in RAL 9010 wit (kleur 79). Andere RAL-kleuren zijn op aanvraag leverbaar. Het is belangrijk om altijd de meegeleverde montage-, onderhoud- en schoonmaakadviezen in acht te nemen!

Meer informatie vindt u op www.hermeta.nl/doorvalbeveiliging.

HERMETA DURCHSTURZSICHERUNG “FEST UND SICHER”

Ein Durchsturzsicherung verhindert, dass Personen aus dem Fenster fallen. Die Durchsturzsicherung aus Aluminium ist nach der europäischen Norm NEN-EN 1991.1.1 zertifiziert. Das bedeutet unter anderem, dass es eine Stoßeinwirkung mit einer kinetischen Energie von 0,5 kNm aufnehmen kann. Wenn der Abstand zwischen zwei Stützen zu groß wird, sind Mittelstützen erforderlich.

Die Durchsturzsicherung ist für neue und bestehende Häuser oder Gebäude, für den Innen- und Außenbereich sowie für auf und zwischen dem Fensterrahmen geeignet. Die Aluminiumrohre (rund oder viereckig) können in Standardlängen oder nach Maß geliefert werden. Die Artikel werden standardmäßig in matt silber eloxiert (Farbe 11) oder mit einer Pulverbeschichtung in RAL 9010 weiß (Farbe 79) geliefert. Andere RAL-Farben sind auf Anfrage erhältlich. Es ist wichtig, dass die mitgelieferten Installations-, Wartungs- und Reinigungsempfehlungen immer beachtet werden!

Weitere Informationen finden Sie unter www.hermeta.nl/doorvalbeveiliging.

HERMETA “FIRM AND SURE” FALL PROTECTION

Fall protection prevents people from falling out of a window. This fall protection, made of aluminium, is certified according to the European standard NEN-EN 1991.1.1. This means, among other things, that it can absorb an impact load with a kinetic energy of 0.5 kNm. Intermediate supports are required if the span between the two supports becomes too large.

This fall protection is suitable for new and existing homes or buildings, indoor and outdoor use and in front or between the window frame mounting. The aluminium tubes (round or square) can be supplied in standard lengths or specially made to measure. The articles are supplied as standard in matt silver anodised (colour 11) or with a powder coating in RAL 9010 white (colour 79). Other RAL colours are available on request. It is important to always observe the installation, maintenance and cleaning recommendations supplied!

More information can be found at www.hermeta.nl/doorvalbeveiliging.

BARRE DE PROTECTION HERMETA “FIXE ET SURE”

Une barre de protection permet de prévenir des chutes des fenêtres. Cette barre de protection, faite en aluminium, a été certifiée selon la norme européenne NEN-EN 1991.1.1. Cela signifie entre autres qu'elle peut résister à un impact de choc avec une énergie cinétique de 0,5 Ec. Il faut prévoir des soutiens intermédiaires si l'envergure entre deux supports devient trop grande.

La barre de protection convient aux bâtiments neufs mais aussi à des habitations existantes, tant à l'intérieur qu'à l'extérieur, tant le montage sur ou entre le cadre de la fenêtre. Les tubes en aluminium (ronds ou carrés) peuvent être livrés avec des longueurs standards ou coupés spécialement sur mesure. Les articles sont livrés standard en argent mat anodisé. (couleur 11). D'autres couleurs RAL-peuvent être livrées sur demande. Il importe de respecter toujours les consignes de montage, d'entretien et de nettoyage qui sont livrées avec

Pour des renseignements plus amples, consultez www.hermeta.nl/doorvalbeveiliging.



ONDERDELEN DOORVALBEVEILIGING



NEN-EN 1991.1.1 GECERTIFICEERD

KOKER VOOR DOORVALBEVEILIGING	ROHR ZUR ABSTURZSICHERUNG	TUBE FOR FALL PREVENTION	BARRE DE PROTECTION
van aluminium profiel	Aluminiumprofil	extruded aluminium	en profilé d'aluminium
vierkant 28 x 28 x 3,5 m 3650 - L = 3000 mm 3651 - L = 1000 mm (alleen in -79) 3652 - L = 1500 mm (alleen in -79)	kwadratisch 28 x 28 x 3,5 m 3650 - L = 3000 mm 3651 - L = 1000 mm (nur in -79) 3652 - L = 1500 mm (nur in -79)	square 28 x 28 x 3,5 m 3650 - L = 3000 mm 3651 - L = 1000 mm (only in -79) 3652 - L = 1500 mm (only in -79)	carré 28 x 28 x 3,5 m 3650 - L = 3000 mm 3651 - L = 1000 mm (seulement en -79) 3652 - L = 1500 mm (seulement en -79)
rond/ovaal 28 x 26 x 3 mm 3850 - L = 3000 mm 3851 - L = 1000 mm (alleen in -79) 3852 - L = 1500 mm (alleen in -79)	rund/oval 28 x 26 x 3 mm 3850 - L = 3000 mm 3851 - L = 1000 mm (nur in -79) 3852 - L = 1500 mm (nur in -79)	round/oval 28 x 26 x 3 mm 3850 - L = 3000 mm 3851 - L = 1000 mm (only in -79) 3852 - L = 1500 mm (only in -79)	rond/ovale 28 x 26 x 3 mm 3850 - L = 3000 mm 3851 - L = 1000 mm (seulement en -79) 3852 - L = 1500 mm (seulement en -79)
geanodiseerd -11 mat naturel	eloxiert -11 matt silber	anodized -11 matt silver	anodisé -11 argent mat
geëpoxideerd -79 wit	pulverbeschiktet -79 weiß	epoxy plastic coated -79 white	thermolaqué -79 blanc

STEUNEN	TRÄGER	BRACKETS	SUPPORTS
van aluminium profiel	Aluminiumprofil	extruded aluminium	en profilé d'aluminium
vierkant 3670 - op de dag, 3675 - in de dag, 3679 - middensteun	kwadratisch 3670 - bevestiging auf die Wand, 3675 - für seitliche befestigung, 3679 - Mittelträger	square 3670 - on the wall mounting, 3675 - side wall mounting, 3679 - middle bracket	carré 3670 - pour fixation murale, 3675 - pour fixation laterale, 3679 - support intermédiaire
rond/ovaal 3870 - op de dag, 3875 - in de dag, 3879 - middensteun	rund/oval 3870 - bevestiging auf die Wand, 3875 - für seitliche befestigung, 3879 - Mittelträger	round/oval 3870 - on the wall mounting, 3875 - side wall mounting, 3879 - middle bracket	rond/ovale 3870 - pour fixation murale, 3875 - pour fixation laterale, 3879 - support intermédiaire
geanodiseerd -11 mat naturel	eloxiert -11 matt silber	anodized -11 matt silver	anodisé -11 argent mat
geëpoxideerd -79 wit	pulverbeschiktet -79 weiß	epoxy plastic coated -79 white	thermolaqué -79 blanc



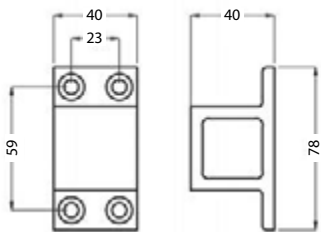

3670 | 3679

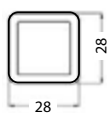

3650

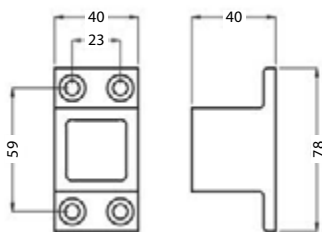

3675

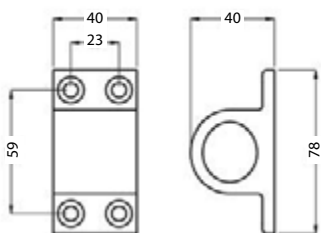

3870 | 3879

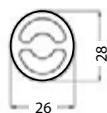

3850

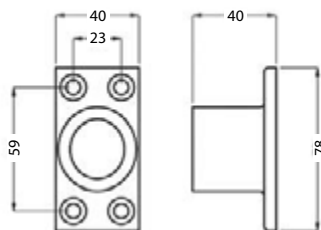

3875





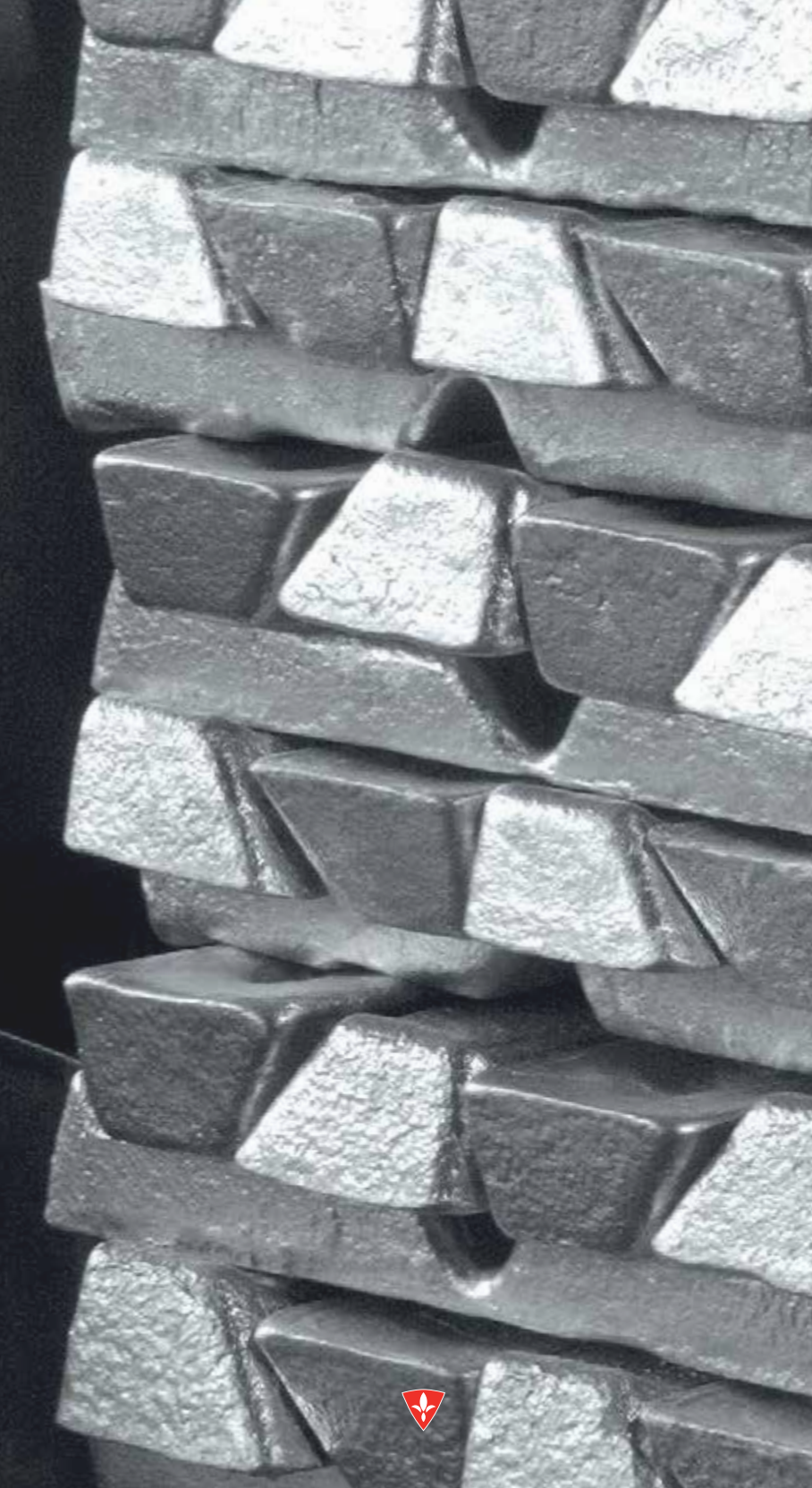

**7 Diversen en
bevestigingsmateriaal**

**7 Verschiedenes und
Befestigungsmaterial**

**7 Miscellaneous and
mounting material**

**7 Divers et
matériel de montage**



WANDAFVALBAK



3275

3280

WANDAFVALBAK	WAND ABFALLBEHÄLTER	WASTE BIN, WALL MOUNTING	POUBELLE À FIXER SUR PAROI
van aluminium profiel	Aluminiumprofil	extruded aluminium	en profilé d'aluminium
naturel geanodiseerd eindkappen gegoten en geëpoxeerd blauw RAL 5011	silber eloxiert endkappen pulverbe- schichtet blau RAL 5011	silver anodized end caps cast aluminium epoxy plastic coated blue RAL 5011	anodisé argent embouts en fonte d'aluminium thermolaqué bleu RAL 5011
3275-753 inhoud 2,5 liter	3275-753 Inhalt 2,5 liter	3275-753 content 2,5 liter	3275-753 contenance 2,5 liter
3280-753 inhoud 3,5 liter	3280-753 Inhalt 3,5 liter	3280-753 content 3,5 liter	3280-753 contenance 3,5 liter

	L
3275	210 mm
3280	280 mm

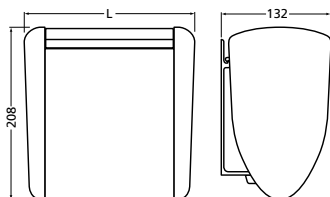

DOPMOEREN



5855

5865

DOPMOER	HUTMUTTER	DOME HEADED NUT	ECROU BORGNE
aluminium	aluminium	aluminium	aluminium
5855 - M6 5865 - M8	5855 - M6 5865 - M8	5855 - M6 5865 - M8	5855 - M6 5865 - M8
5866 - M8 verpakt per 5 stuks	5866 - M8 verpakt pro 5 Stück	5866 - M8 packed per 5 pieces	5866 - M8 emballé par 5 pièces
geanodiseerd -01 naturel -18 zwart	eloxiert -01 silber -18 schwarz	anodized -01 naturel -18 black	anodisé -01 argent -18 noir



STOKSCHROEF



5935

STOKSCHROEF	STOCKSCHRAUBE	HANGER BOLT	BOULON DE SUSPENSION
5935 M8 x 60 mm	5935 M8 x 60 mm	5935 M8 x 60 mm	5935 M8 x 60 mm
-99 staal verzinkt	-99 Stahl, verzinkt	-99 staal verzinkt	-99 en acier galvanisé







8 Garderobes

8 Garderoben

8 Cloackroom systems

8 Vestiaires



GARDEROBES

INTRODUCTIE GARDEROBES

In deze catalogus vindt u een overzicht van de garderobes uit het assortiment van Hermeta. Alle producten worden door Hermeta zelf geproduceerd in haar moderne, goed geoutilleerde fabriek te Asperen (Gld.). Hierdoor is Hermeta in staat veel zorg aan afwerking en kwaliteit van haar producten te besteden. Het ontwerpteam van Hermeta houdt zich voortdurend bezig met verbetering van de bestaande garderobesystemen en de ontwikkeling van nieuwe modellen. Het resultaat hiervan is een reeks garderobesystemen die uitblinkt in kwaliteit en functionaliteit. Hermeta garderobes zijn bij uitstek geschikt voor toepassing in kantoren, hotels, kerken, restaurants, theaters, scholen, sportinstellingen, enz. Ook in woningen zijn zij uitstekend toe te passen.

De Gardelux garderobes voldoen aan alle criteria voor Duurzaam Inkopen van Kantoormeubilair.

GARDELUX 1:
pagina 90 - 108

GARDELUX 2:
pagina 110 - 127

EINLEITUNG GARDEROBEN

In diesem Katalog finden Sie eine Übersicht der Garderoben aus dem Assortiment von Hermeta. Alle Produkte werden von Hermeta selbst in ihrer modernen, gut ausgestatteten Fabrik in Asperen in der niederländischen Provinz Gelderland hergestellt. Hierdurch ist Hermeta in der Lage, der Verarbeitung und Qualität ihrer Produkte die grösste Aufmerksamkeit zu schenken. Das Designer-Team von Hermeta beschäftigt sich hauptsächlich mit der Verbesserung der bestehenden Garderobensysteme und der Entwicklung von neuen Modellen. Hierdurch ist eine Serie von Garderobensysteme entstanden, die sich durch Qualität und Funktionalität auszeichnet. Hermeta Garderoben sind hervorragend für die Anbringung in Büros, Hotels, Kirchen, Restaurants, Schulen, Theatern, Sporthallen, usw. geeignet. Aber auch für Privatwohnungen sind diese Garderoben eine Bereicherung.

Die Gardelux Garderoben erfüllen alle Kriterien für Nachhaltig einkaufen von Büromöbel.

GARDELUX 1:
Seite 90 - 108

GARDELUX 2:
Seite 110 - 127



GARDEROBES

INTRODUCTION CLOAKROOM SYSTEMS

This catalogue aims to give you an overview of the wide range of cloakroom systems carried by Hermeta. All products are made by Hermeta itself in its state-of-the-art, well equipped factory in Asperen (Gelderland, the Netherlands), enabling Hermeta to exercise extreme care over the quality and finish of its products. Hermeta's team of designers is continuously engaged in the improvement of the existing cloakroom systems and the development of new models, resulting in a series of cloakroom systems which are unrivalled for quality and functionality. Hermeta's cloakroom systems are pre-eminently suitable for use in offices, hotels, churches, restaurants, theatres, schools, leisure centres, etc. On top of that, they are also highly suitable for use at home.

The Gardelux cloakroom systems meets all the criteria for sustainable purchasing of office furniture.

GARDELUX 1:
page 90 - 108

GARDELUX 2:
page 110 - 127

INTRODUCTION VESTIAIRES

Ce catalogue présente un aperçu des vestiaires que propose Hermeta dans son assortiment. Tous les produits sont fabriqués par l'entreprise Hermeta même, dans son usine moderne et bien équipée d'Asperen (Gueldre, Pays-Bas). Hermeta est ainsi en mesure de consacrer beaucoup d'attention à la finition et à la qualité de ses produits. L'équipe de conception cherche continuellement à améliorer les vestiaires actuelles et à développer de nouveaux modèles. Le résultat de ces efforts est constitué par une série de vestiaires qui se distinguent par leur qualité et leur aspect fonctionnel. Les vestiaires produites par Hermeta sont destinées par excellence aux bureaux, hôtels, églises, restaurants, théâtres, établissements sportifs, écoles, etc. Il est aussi tout à fait possible de les utiliser dans des habitations.

Les vestiaires Gardelux répondent à tous les critères pour marcher durable mobilier de bureau.

GARDELUX 1:
page 90 - 108

GARDELUX 2:
page 110 - 127



GARDEROBES | GARDELUX 1

GARDELUX 1

GARDELUX 1 is door haar fraaie, tijdloze vormgeving geschikt voor vele toepassingen. Het modulair opgebouwde garderobesysteem bestaat uit ovale buizen die als dragers voor de haken en als aflegprofiel (voor hoeden) gebruikt worden. In deze catalogus vindt u een groot aantal verschillende typen. Daarnaast zijn er nog talloze mogelijkheden door toepassing van andere haken en/of kledinghangers. Deze combinatiemogelijkheden stellen u in staat om een garderobe te kiezen die optimaal aan uw wensen voldoet.

Kenmerken GARDELUX 1: elke lengte is leverbaar; materiaal: geanodiseerd aluminium; hart-op-hart afstand van de haken: 15 cm; van de kledinghangers 10 cm; indien gewenst kan men hiervan afwijken.

GARDELUX 1

Das System GARDELUX 1 ist durch seine schöne, zeitlose Formgebung für viele Anwendungsbereiche geeignet. Das aus Bauteilen zusammengesetzte Garderobensystem besteht aus ovalen Rohren, die als Halter für die Haken und als Ablageprofil (für Hüte) verwendet werden. In diesem Katalog finden Sie eine Vielzahl von verschiedenen Typen. Darüber hinaus gibt es noch zahllose andere Möglichkeiten, indem andere Haken und/oder andere Kleiderbügel verwendet werden. Durch diese Kombinationsmöglichkeiten sind Sie in der Lage, eine Garderobe zusammenzustellen, die ganz Ihren Wünschen entspricht.

Eigenschaften der GARDELUX 1: in allen Längen lieferbar; Material: eloxiertes Aluminium; der Mittelabstand zwischen den Haken beträgt 15 cm und zwischen den Kleiderbügel 10 cm; auf Wunsch können diese Abstände geändert werden.

GARDELUX 1

Due to its beautiful and ageless design, the GARDELUX 1 is suitable for a wide range of applications. This modular hat and coat rack system consists of oval tubes, serving both as supports for the hooks and shelf space (for hats). This catalogue will introduce you to a great variety of types. The possibilities created by using other hooks and/or coat hangers are numerous. These combination possibilities enable you to choose a hat and coat rack system which is fine-tuned to your needs.

Features GARDELUX 1: available in any chosen length; material: anodized aluminium; centre to centre distance hooks: 15 cm; coat hangers: 10 cm; if so desired, the above can be deviated from.

GARDELUX 1

Par son esthétique et indémodable, GARDELUX 1 se prête à beaucoup d'applications. La vestiaire à construction modulaire comprend des tubes de forme ovale qui sont employés comme supports de crochets et espaces où déposer des chapeaux, par exemple. Vous trouverez dans ce catalogue un grand nombre de modèles différents. L'utilisation d'autres crochets et/ou de cintres permet en outre d'obtenir d'innombrables possibilités. Toutes ces combinaisons possibles vous mettent en mesure de choisir une vestiaire qui réponde de façon optimale à vos désirs.

Voici les caractéristiques de GARDELUX 1: livrable dans toutes les longueurs désirées; matériau: aluminium anodisé; la distance entre axe des crochets s'élève à 15 cm, celle des cintres à 10 cm; il est possible, si désiré, d'obtenir des mesures différentes.





◀58▶



type 1

1010 | 1030 | 1032 | 1201

◀135▶



type 3

1010 | 1050 | 1052 | 1201



GARDEROBES | GARDELUX 1

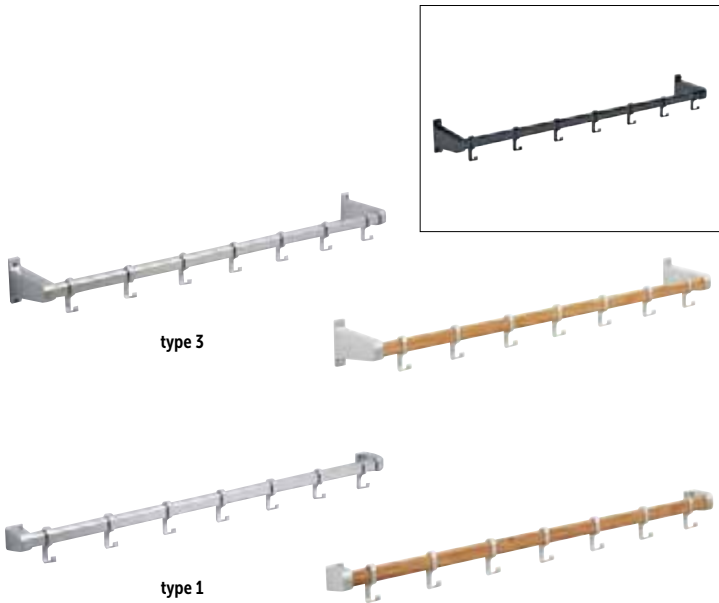

type 3

type 1

TYPE 1-3	TYP 1-3	TYPE 1-3	TYPE 1-3
De garderobes kunnen op elke gewenste lengte tot 5000 mm geleverd worden.	Die Garderoben können in jeder gewünschten Länge bis 5000 mm geliefert werden.	These coat racks are available in any chosen length till 5000 mm.	Les vestiaires peuvent être livrées dans toutes les longueurs désirées à 5000 mm.
De garderobe in combinatie met eikenhout heeft een maximale lengte van 1500 mm.	Die Garderobe in Kombination mit Eichenholz hat eine maximale Länge von 1500 mm.	The wardrobe in combination with oak wood has a maximum length of 1500 mm.	Le vestiaire en combinaison avec du bois de chêne a une longueur maximale de 1500 mm.
De getoonde typen 1 en 3 zijn voorzien van de terugspringende jashaak 1201 .	Die hier abgebildeten Typen 1 und 3 sind mit dem zurückliegenden Mantelhaken 1201 versehen.	The types 1 and 3, as shown on this page, are equipped with receding coathooks 1201 .	Les modèles 1 et 3 présentés disposent des crochets retraités pour manteaux 1201 .
Andere hoed- en jashaken staan op pagina 107.	Andere Hut- und Mantelhaken sind auf Seite 107 abgebildet.	For other hat and coathooks please refer to page 107.	D'autres crochets pour manteaux et chapeaux se trouvent à la page 107.



GARDEROBES | GARDELUX 1

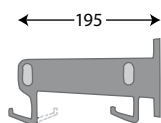

type 5

1010 | 1080 | 1081 | 1082 | 1201

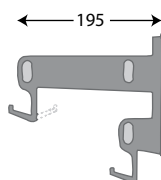

type 6

1010 | 1090 | 1091 | 1092 | 1201

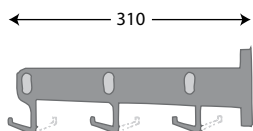

type 7

1010 | 1110 | 1111 | 1112 | 1201



GARDEROBES | GARDELUX 1



type 5



type 6



type 7

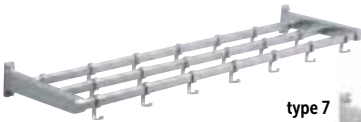
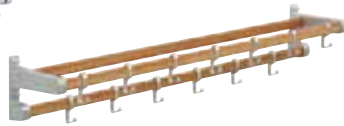

TYPE 5-6-7	TYP 5-6-7	TYPE 5-6-7	TYPE 5-6-7
De garderobes kunnen op elke gewenste lengte tot 5000 mm geleverd worden.	Die Garderoben können in jeder gewünschten Länge bis 5000 mm geliefert werden.	These coat racks are available in any chosen length till 5000 mm.	Les vestiaires peuvent être livrées dans toutes les longueurs désirées à 5000 mm.
De garderobe in combinatie met eikenhout heeft een maximale lengte van 1500 mm.	Die Garderobe in Kombination mit Eichenholz hat eine maximale Länge von 1500 mm.	The wardrobe in combination with oak wood has a maximum length of 1500 mm.	Le vestiaire en combinaison avec du bois de chêne a une longueur maximale de 1500 mm.
De getoonde typen 5-7 zijn voorzien van de terugspringende jashaak 1201 .	Die hier abgebildeten Typen 5 - 7 sind mit dem zurückliegenden Mantelhaken 1201 versehen.	The types 5 - 7, as shown on this page, are equipped with receding coathooks 1201 .	Les modèles 5 - 7 présentés disposent des crochets retraités pour manteaux 1201 .
Anderse hoed- en jashaken staan op pagina 107.	Anderse Hut- und Mantelhaken sind auf Seite 107 abgebildet.	For other hat and coathooks please refer to page 107.	D'autres crochets pour manteaux et chapeaux se trouvent à la page 107.
Alle wandgarderobes kunnen ook op een frame gemonteerd worden (pag. 140 - 141).	Alle Wandgarderoben können auch auf einem Rahmen montiert werden (Seite 140 - 141).	All hat and coat racks can also be mounted on a frame (page 140 - 141).	Toutes les vestiaires peuvent être installées sur un cadre (pages 140 - 141).



GARDEROBES | GARDELUX 1

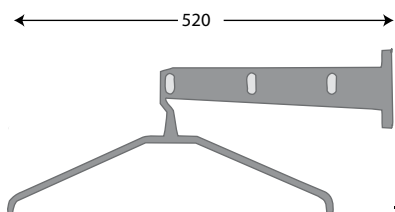

type 7a

1010 | 1110 | 1111 | 1112 | 1201

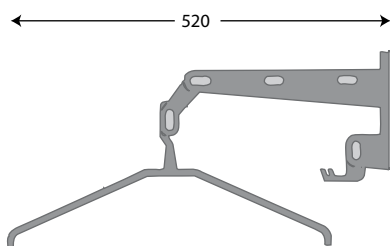

type 13

1010 | 1140 | 1141 | 1142

1150 | 1151 | 1152 | 1231 | 1262



GARDEROBES | GARDELUX 1

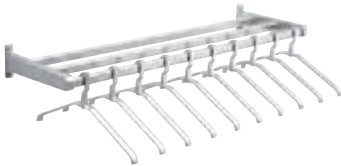

type 7a

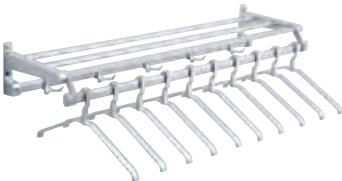
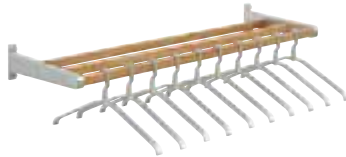

type 13



TYPE 7a-13	TYP 7a-13	TYPE 7a-13	TYPE 7a-13
De garderobes kunnen op elke gewenste lengte tot 5000 mm geleverd worden.	Die Garderoben können in jeder gewünschten Länge bis 5000 mm geliefert werden.	These coat racks are available in any chosen length till 5000 mm.	Les vestiaires peuvent être livrées dans toutes les longueurs désirées à 5000 mm.
De garde robe in combinatie met eikenhout heeft een maximale lengte van 1500 mm.	Die Garderobe in Kombination mit Eichenholz hat eine maximale Länge von 1500 mm.	The wardrobe in combination with oak wood has a maximum length of 1500 mm.	Le vestiaire en combinaison avec du bois de chêne a une longueur maximale de 1500 mm.
De getoonde typen 7a en 13 zijn voorzien van de kledinghanger 1262 , en type 13 van dubbele jashaken 1231 .	Die hier abgebildeten Typen 7a und 13 sind mit dem Kleiderbügel 1262 versehen, und Typ 13 mit doppelten Mantelhaken 1231 .	The types 7a and 13, as shown on this page, are equipped with coat hanger 1262 , and type 13 with double coat hooks 1231 .	Les modèles 7a et 13 présentés disposent des cintres 1262 , et modèle 13 avec crochets double pour manteaux 1231 .
Alle wandgarderobes kunnen ook op een frame gemonteerd worden (pag. 140 - 141).	Alle Wandgarderoben können auch auf einem Rahmen montiert werden (Seite 140 - 141).	All hat and coat racks can also be mounted on a frame (page 140 - 141).	Toutes les vestiaires peuvent être installées sur un cadre (pages 140 - 141).



GARDEROBEBUIS | GARDELUX 1

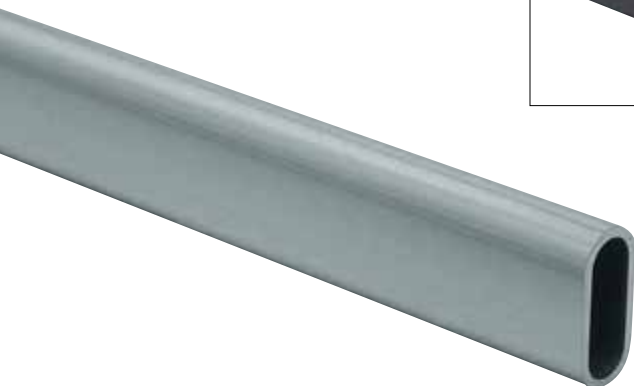

1010 - 1014 - 1015 - 1016 - 1017 - 1018 - 1019

GARDEROBEBUIS	GARDEROBENROHR	WARDROBETUBE	TRINGLE
aluminium profiel	Aluminiumprofil	aluminium profile	en profilé d'aluminium
recht ovaal	flach oval	flat oval	ovale et aplatie
30 x 14 x 2 mm	30 x 14 x 2 mm	30 x 14 x 2 mm	30 x 14 x 2 mm
geanodiseerd -01 naturel -18 zwart	eloxiert -01 silber -18 schwarz	anodized -01 silver -18 black	anodisé -01 argent -18 noir
-18 niet verkrijgbaar in 5000 mm	-18 nicht verfügbar in 5000 mm	-18 not available in 5000 mm	-18 non disponible en 5000 mm

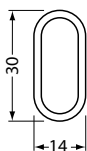

	L
1015	1000 mm
1016	1250 mm
1017	1500 mm
1014	2000 mm
1018	2500 mm
1019	3000 mm
1010	5000 mm



STEUNEN | GARDELUX 1

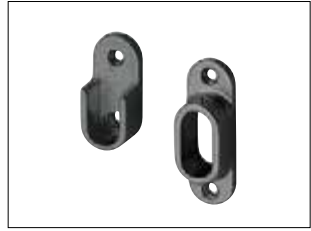

1170



1175

STEUNEN IN DE DAG	WANDLAGER FÜR SEITLICHE BEFESTIGUNG	END BRACKETS FOR SIDE WALL MOUNTING	SUPPORTS D'EXTREMITES POUR FIXATION LATERALE
gegoten aluminium	Aluminiumguss	cast aluminium	en fonte d'aluminium
geanodiseerd -01 naturel	eloxiert -01 silber	anodized -01 silver	anodisé -01 argent
geëpoxeerd -70 zwart	pulverbeschichtet -70 schwarz	epoxy plastic coated -70 black	thermolaqué -70 noir

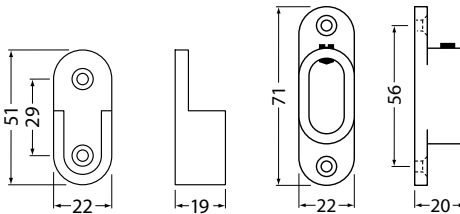

STEUNEN | GARDELUX 1



1030



1032

STEUNEN	TRÄGER	BRACKETS	SUPPORTS
van aluminium profiel	Aluminiumprofil	extruded aluminium	en profilé d'aluminium
1030 eindsteun 1032 middensteun	1030 Endträger 1032 Mittelträger	1030 end bracket 1032 middle bracket	1030 supports d'extrémités 1032 supports intermédiaires
geanodiseerd -01 naturel	eloxiert -01 silber	anodized -01 silver	anodisé -01 argent
geëpoxeerd -18 zwart	pulverbeschichtet -18 schwarz	epoxy plastic coated -18 black	thermolaqué -18 noir

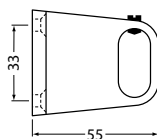
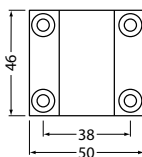
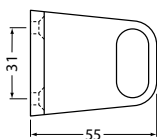
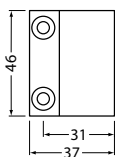

STEUNEN | GARDELUX 1



1190 | 1192



1194 | 1196

STEUNEN VOOR PLAFONDBEVESTIGING	TRÄGER FÜR DECKENBEFESTIGUNG	BRACKETS FOR CEILING MOUNTING	SUPPORTS POUR FIXATION AU PLAFOND
van aluminium profiel	Aluminiumprofil	extruded aluminium	en profilé d'aluminium
opschroevend 1190 eindsteun 1192 middensteun met borgschroefje	zum Aufschrauben 1190 Endträger 1192 Mittelträger mit Fixierschraube	2 fixing holes 1190 end bracket 1192 middle bracket with locking screw	2 trous de montage 1190 support d'extrémité 1192 support intermédiaire avec vis de serrage
met taggat M6 1194 eindsteun 1196 middensteun met borgschroefje	mit Gewindebohrung M6 1194 Endträger 1196 Mittelträger mit Fixierschraube	with M6 threaded hole 1194 end bracket 1196 middle bracket with locking screw	avec trou taraudé M6 1194 support d'extrémité 1196 support intermédiaire avec vis de serrage
geanodiseerd -01 naturel -11 mat naturel	eloxiert -01 silber -11 matt silber	anodized -01 silver -11 matt silver	anodisé -01 argent -11 argent mat
geëpoxeerd -18 zwart	pulverbeschichted -18 schwarz	epoxy plastic coated -18 black	thermolaqué -18 noir

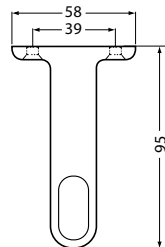
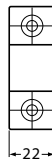
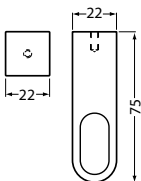

STEUNEN | GARDELUX 1

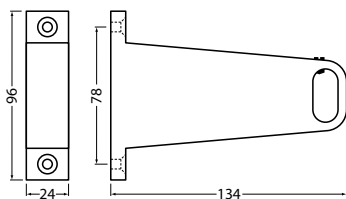

1050 | 1052

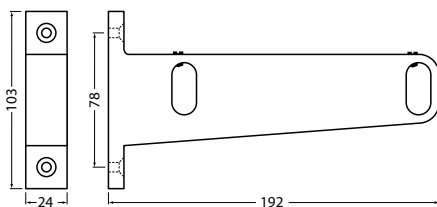

1080 | 1081 | 1082

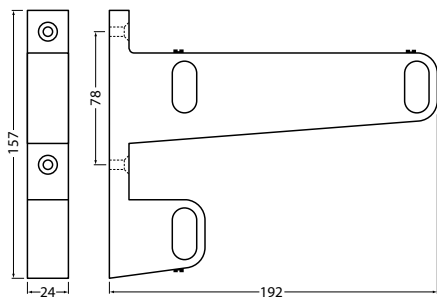

1090 | 1091 | 1092



STEUNEN | GARDELUX 1



1050 | 1052



1080 | 1081 | 1082



1090 | 1091 | 1092

STEUNEN	TRÄGER	BRACKETS	SUPPORTS
van aluminium profiel	Aluminiumprofil	extruded aluminium	en profilé d'aluminium
1050 eindsteun links en rechts 1080 en 1090 eindsteunen links 1081 en 1091 eindsteunen rechts 1052, 1082 en 1092 middensteunen geanodiseerd -01 naturel geëpoxeerd -18 zwart	1050 Endträger links und rechts 1080 und 1090 Endträger links 1081 und 1091 Endträger rechts 1052, 1082 und 1092 Mittelträger eloxiert -01 silber pulverbeschichtet -18 schwarz	1050 left and right hand bracket 1080 and 1090 left hand bracket 1081 and 1091 right hand bracket 1052, 1082 and 1092 middle bracket anodized -01 silver epoxy plastic coated -18 black	1050 support d'extrémité gauche et droite 1080 et 1090 support d'extrémité gauche 1081 et 1091 support d'extrémité droite 1052, 1082 et 1092 support intermédiaire anodisé -01 argent thermolaqué -18 noir



STEUNEN | GARDELUX 1

1110 | 1111 | 1112

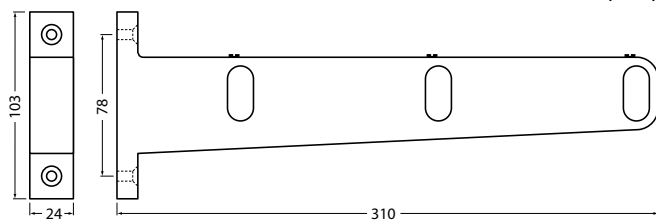

1140 | 1141 | 1142

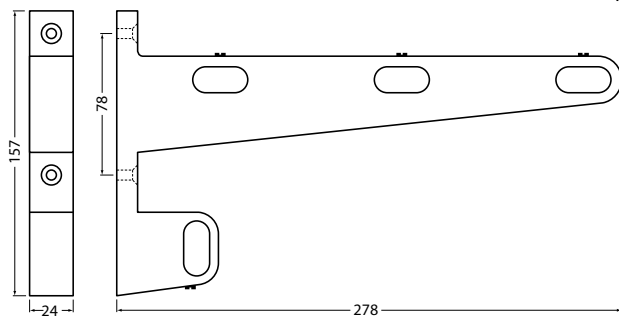

STEUNEN | GARDELUX 1



1199 | 2095

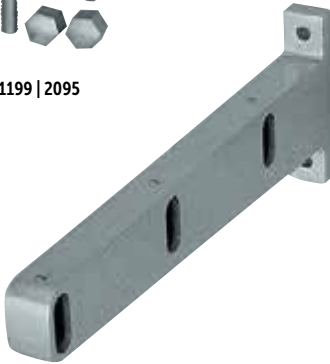

1110 | 1111 | 1112



1140 | 1141 | 1142

STEUNEN	TRÄGER	BRACKETS	SUPPORTS
van aluminium profiel	Aluminiumprofiel	extruded aluminium	en profilé d'aluminium
1110 en 1140 eindsteunen links 1111 en 1141 eindsteunen rechts 1112 en 1142 middensteunen geanodiseerd -01 naturel geëpoxideerd -18 zwart	1110 und 1140 Endträger links 1111 und 1141 Endträger rechts 1112 und 1142 Mittelträger eloxiert -01 silber pulverbeschichtet -18 schwarz	1110 and 1140 left hand bracket 1111 and 1141 right hand bracket 1112 and 1142 middle bracket anodized -01 silver epoxy plastic coated -18 black	1110 and 1140 support d'extrémité gauche 1111 and 1141 support d'extrémité droite 1112 and 1142 support intermédiaire anodisé -01 argent thermolaqué -18 noir

MONTAGESET VOOR STEUNEN	MONTAGEZUBEHÖR FÜR TRÄGER	FIXING KIT FOR BRACKETS	FIXATIONS POUR SUPPORTS
inhoud: 2 pluggen 2 stokschroeven M8 x 70 mm 2 dopmoeren M8 1199-01 naturel 2095-18 zwart	Inhalt: 2 Dübel 2 Stokschrauben M8 x 70 mm 2 Hutmuttern M8 1199-01 silber 2095-18 schwarz	contents: 2 threaded screws M8 x 70 mm 2 M8 domeheaded nuts 1199-01 silver 2095-18 black	composition: 2 chevilles 2 vis captives M8 x 70 mm 2 écrous borgnes M8 1199-01 argent 2095-18 noir



STEUNEN | GARDELUX 1



1150 | 1151 | 1152

BEUGELS VOOR BEVESTIGING AAN GARDEROEBEUIS	TRÄGER FÜR BEFESTIGUNG AN GARDEROBENROHR	HANGING BRACKETS FOR FIXING TO WARDROBE TUBE	SUPPORTS POUR TRINGLE DE VESTIAIRE
gegoten aluminium	Aluminiumguss	cast aluminium	en fonte d'aluminium
1150 eindbeugel links 1151 eindbeugel rechts 1152 middenbeugel	1150 Endträger links 1151 Endträger rechts 1152 Mittelträger	1150 left hand bracket 1151 right hand bracket 1152 middle bracket	1150 d'extrémité gauche 1151 d'extrémité droite 1152 support intermédiaire
geanodiseerd -01 naturel	eloxiert -01 silber	anodized -01 silver	anodisé -01 argent
geëpoxideerd -70 zwart	pulverbeschichtet -70 schwarz	epoxy plastic coated -70 black	thermolaqué -70 noir

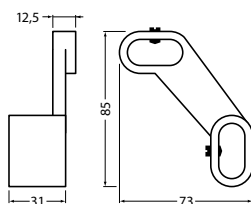

GARDEROBEHAKEN GARDELUX 1



1201



1221



1231

GARDEROBEHAKEN	GARDEROBENHAKEN	HAT AND COAT HOOKS	CROCHETS DE VESTIAIRE
aluminium	Aluminium	aluminium	aluminium
Alle haken met borgschroefje	Alle Haken mit Fixier-schraube	All hooks have locking screw	Tous crochets avec vis de serrage
1201 geanodiseerd -01 naturel	1201 eloxiert -01 silber	1201 anodized -01 silver	1201 anodisé -01 argent
geëpoxideerd -18 zwart	pulverbeschichtet -18 schwarz	epoxy plastic coated -18 black	thermolaqué -18 noir
1221 en 1231 geanodiseerd -01 naturel	1221 und 1231 eloxiert -01 silber	1221 and 1231 anodized -01 silver	1221 et 1231 anodisé -01 argent
geëpoxideerd -70 zwart	pulverbeschichtet -70 schwarz	epoxy plastic coated -70 black	thermolaqué -70 noir

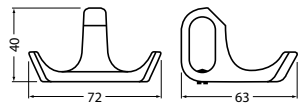
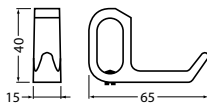
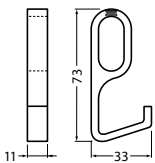

KLEDINGHANGERS GARDELUX 1



1262



1266

KLEDINGHANGERS	KLEIDERBÜGEL	COAT HANGERS	CINTRES
aluminium	Aluminium	aluminium	aluminium
1262 zelfrichtend 1266 niet afneembaar, draaibaar	1262 selbstrichtend 1266 nicht abnehmbar, drehbar	1262 selfaligning 1266 non removable, swivelling	1262 non pivotant 1266 anti-vol, pivotant
geanodiseerd -01 naturel	eloxiert -01 silber	anodized -01 silver	anodisé -01 argent
geëpoxideerd -18 zwart	pulverbeschichtet -18 schwarz	epoxy plastic coated -18 black	thermolaqué -18 noir

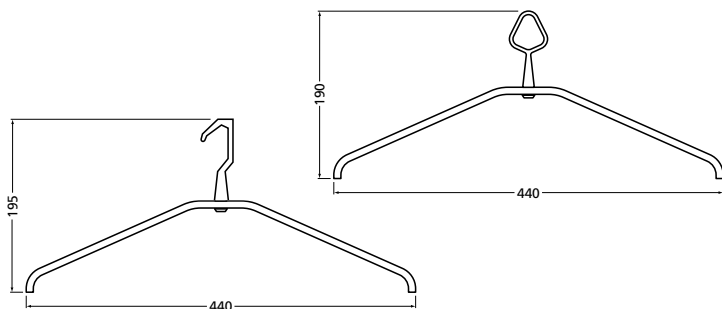



GARDEROBES | GARDELUX 2

GARDELUX 2

Garderobe Gardelux 2 valt op door zijn strakke aluminium lijsten gecombineerd met zwarte haken en zwarte eindstops. Sleutelwoorden voor dit garderobeprogramma zijn functionaliteit en degelijkheid. De getoonde garderobes zijn bijna allemaal leverbaar met de haken en kledinghangers zoals afgebeeld op pag. 122 en 123. De vrijstaande garderobeframes worden veelvuldig toegepast als units, wanneer bevestiging op de wand niet mogelijk of gewenst is. Ook voor Gardelux 2 geldt dat u door de vele mogelijkheden in staat bent een garderobe te kiezen die optimaal voldoet aan uw wensen. Kenmerken Gardelux 2: elke lengte is leverbaar; profiel en kledinghangers: aluminium mat naturel (kledinghangers met zwarte haken); hart-op-hart afstand van de haken: 15 cm; van de kledinghangers 10 cm; indien gewenst kan men hiervan afwijken.

GARDELUX 2

Das Garderobensystem Gardelux 2 fällt durch seine gerade Aluminiumprofile in Kombination mit schwarzen Haken und schwarzen Endkappen auf. Bei diesem Garderobenprogramm dreht sich alles um Funktionalität und Solidität. Die hier gezeigten Garderoben sind nahezu alle mit den auf Seite 122 und 123 abgebildeten Haken und Kleiderbügel lieferbar. Die freistehenden Garderobenrahmen werden oft als Elemente verwendet, wenn eine Befestigung an der Wand nicht möglich oder nicht erwünscht ist. Auch für das System Gardelux 2 gilt, dass Sie durch die vielen Möglichkeiten eine Garderobe zusammenstellen können, die Ihren Wünschen völlig entspricht. Eigenschaften der Gardelux 2: in allen Längen lieferbar; Material der Profile und Kleiderbügel: Aluminium silber matt (Kleiderbügel mit schwarzen Haken); der Mittelabstand zwischen den Haken beträgt 15 cm und zwischen den Kleiderbügel 10 cm; auf Wunsch können diese Abstände geändert werden.

GARDELUX 2

The Gardelux 2 immediately catches the eye thanks to its austere aluminium frame combined with black hooks and black end caps. The key words for this hat and coat rack programme are functionality and solidity. Nearly all hat and coat racks featured in this catalogue are available with the hooks and coat hangers shown at pages 122 and 123. The freestanding hat and coat stands are frequently used as units, when wall mounting is either impossible or undesired. The many combination possibilities of the Gardelux 2 enable you to choose a hat and coat rack system that is fine-tuned to your needs. Features Gardelux 2: available in any chosen length; frame and coat hangers: aluminium matt silver (coat hangers with black hooks); centre to centre distance hooks: 15 cm; coat hangers: 10 cm; if so desired, the above can be deviated from.

GARDELUX 2

Vestiaires Gardelux 2 se distingue par son cadre en aluminium rigide combiné à des crochets et des embouts noir. Fonctionnalité et solidité forment les deux mots-clé de cette série. Pratiquement toutes les vestiaires présentées sont livrables avec les crochets et cintres exposés à pages 122 et 123. Les éléments de vestiaire indépendants sont fréquemment utilisés comme unité autonome lorsque l'on ne peut ou veut pas les fixer à la paroi. Egalement dans le cas de la série Gardelux 2, la multitude de combinaisons possibles vous met en mesure de choisir une vestiaires qui réponde de façon optimale à vos désirs. Voici les caractéristique de Gardelux 2: livrable dans toutes les longueur désirées; le profil et les cintres sont faits d'aluminium argent mat (cintres avec crochets noirs); la distance entre axe des crochets est de 15 cm, celle des cintres de 10 cm; il est possible, si désiré, d'obtenir des mesures différentes.





←52→



type 1

2000 | 2015 | 2083

← 150 →



type 2

2000 | 2081 | 2091

← 150 →

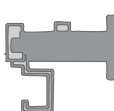

type 3

2000 | 2005 | 2083 | 2091

← 220 →

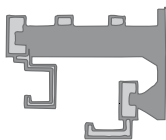

type 6

2000 | 2005 | 2081 | 2083 | 2092

GARDEROBES | GARDELUX 2



type 1



type 2



type 3



type 6

TYPE 1-2-3-6	TYP 1-2-3-6	TYPE 1-2-3-6	TYPE 1-2-3-6
De garderobes kunnen op elke gewenste lengte tot 5000 mm geleverd worden.	Die Garderoben können in jeder gewünschten Länge bis 5000 mm geliefert werden.	These coat racks are available in any chosen length till 5000 mm.	Les vestiaires peuvent être livrés dans toutes les longueurs désirées à 5000 mm.
De getoonde typen 1, 2, 3 en 6 zijn uitgevoerd met jashaak 2081 en/of 2083 .	Die hier abgebildeten Typen 1, 2, 3 und 6 sind mit Mantelhaken 2081 und/oder 2083 versehen.	The types 1, 2, 3 and 6, as shown on this page, are equipped with coathook 2081 and/or 2083 .	Les modèles 1, 2, 3 et 6 présentés disposent des crochets pour manteaux 2081 et/ou 2083 .
Andere haken staan op pagina 122.	Andere Haken sind auf Seite 122 abgebildet.	Other hooks on page 122.	D'autres crochets se trouvent à la page 122.
Wandgarderobe type 6 kan ook op een frame gemonteerd worden (pag. 140 - 141).	Wandgarderoben Typ 6 kann auch auf einem Rahmen montiert werden (Seite 140 - 141).	Hat and coat racks type 6 can also be mounted on a frame (page 140 - 141)	Vestiaires modèle 6 peuvent être également installés sur un cadre (page 140 - 141).

i



GARDEROBES | GARDELUX 2

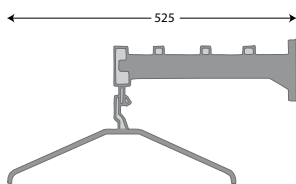

type 9

1262 | 2001 | 2005 | 2093

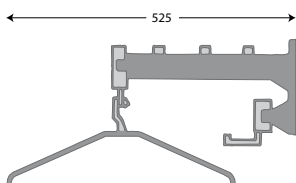

type 10

1262 | 2000 | 2001 | 2005 | 2081 | 2094



GARDEROBES | GARDELUX 2

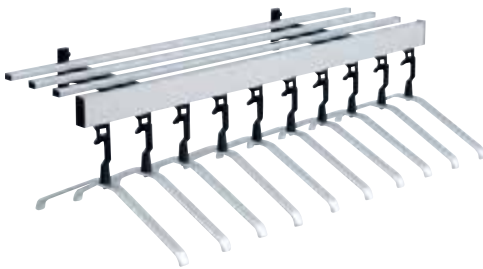

type 9

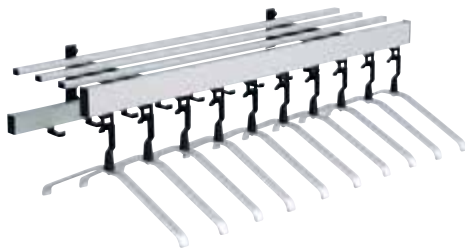

type 10

TYPE 9-10	TYP 9-10	TYPE 9-10	TYPE 9-10
De garderobes kunnen op elke gewenste lengte tot 5000 mm geleverd worden.	Die Garderoben können in jeder gewünschten Länge bis 5000 mm geliefert werden.	These coat racks are available in any chosen length till 5000 mm.	Les vestiaires peuvent être livrées dans toutes les longueurs désirées à 5000 mm.
Het getoonde type 9 is uitgevoerd met kledinghanger 1262 , type 10 met haak 2081 en kledinghanger 1262 ,	Der hier abgebildete Typ 9 ist mit Kleiderbügel 1262 versehen. Typ 10 mit Haken 2081 und Kleiderbügel 1262 .	The type 9, as shown on this page, is equipped with coat hanger 1262 , type 10 with coat hook 2081 and coat hanger 1262 .	Le modèle 9 présenté possède des cintres 1262 , le modèle 10 des crochets 2081 et des cintres 1262 .
Alle wandgarderobes kunnen ook op een frame gemonteerd worden (pag. 140 - 141).	Alle Garderoben können auch auf einem Rahmen montiert werden (Seite 140 - 141).	All coat racks can also be mounted on a frame (page 140 - 141)	Toutes les vestiaires peuvent être également installés sur un cadre (page 140 - 141).



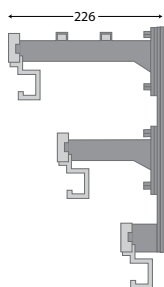

type 12

2000 | 2005 | 2015 | 2083 | 2091 | 2096 | 2354

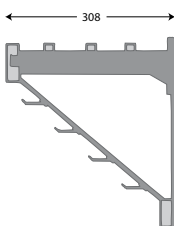

type R

2000 | 2001 | 2005 | 2093 | 2350

GARDEROBES | GARDELUX 2

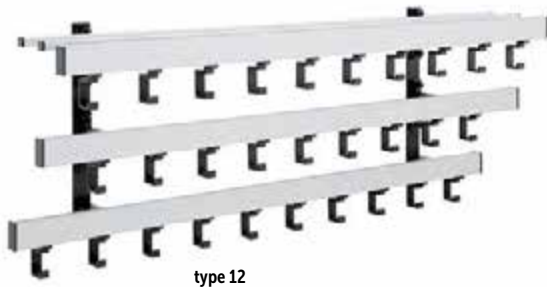

type 12

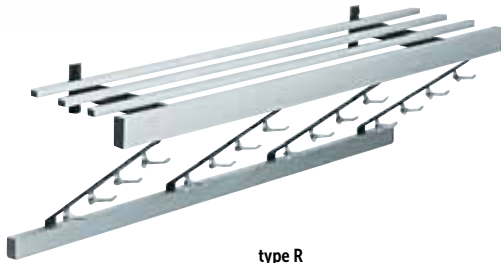

type R

TYPE 12-R	TYP 12-R	TYPE 12-R	TYPE 12-R
De garderobes kunnen op elke gewenste lengte tot 5000 mm geleverd worden.	Die Garderoben können in jeder gewünschten Länge bis 5000 mm geliefert werden.	These coat racks are available in any chosen length till 5000 mm.	Les vestiaires peuvent être livrés dans toutes les longueurs désirées à 5000 mm.
Het getoonde type 12 is uitgevoerd met 3 garderobelijsten en haken 2083 , type R met hakenstrip 2350 .	Der hier abgebildete Typ 12 ist mit 3 Hakenleisten und haken 2083 versehen. Typ R ist mit der Hakenliste 2350 versehen.	The type 12, as shown on this page, is equipped with 3 ledges and coat hooks 2083 . Type R is equipped with hook strip 2350 .	Le modèle 12 présenté 3 profils de vestiaire et crochets 2083 . Le modèle R la bande de crochets 2350 .
Alle wandgarderobes kunnen ook op een frame gemonteerd worden (pag. 140 - 141).	Alle Wandgarderoben können auch auf einem Rahmen montiert werden (Seite 140 - 141).	All hat and coat racks can also be mounted on a frame (page 140 - 141).	C'est possible de monter les vestiaires sur un cadre (page 140 - 141).

i



GARDEROBES | GARDELUX 2



type 10



type R

WANDGARDEROBE	WANDGARDEROBEN	HAT AND COAT RACKS	LES VESTIAIRES MURAUX
Gardelux 2 kunnen op een frame gemonteerd worden.	Gardelux 2 können auch auf einem Rahmen montiert werden.	Gardelux 2 can also be mounted on a frame.	Gardelux 2 peuvent être installées sur un cadre.
Frames en steunen geëpoxeerd in de kleur: -70 zwart RAL 9005	Rahmen und Träger Pulverbeschichtet in den folgenden Farbe: -70 schwarz RAL 9005	Frames and brackets epoxy plastic coated in the following colour: -70 black RAL 9005	Les cadres et supports sont disponibles dans les couleur suivantes thermolaqué: -70 noir RAL 9005
(pag. 140-141).	(Seite 140 - 141).	(page 140 - 141).	(page 140 - 141).



LIJST- EN LEGPROFIEL GARDELUX 2



2000 | 2001

2005

GARDEROBELIJST	GARDEROBENLEISTE	FRONTRAIL	PROFIL DE VESTIAIRE
aluminium profiel	Aluminiumprofil	aluminium profile	en profilé d'aluminium
2000 42 x 16 mm 2001 56 x 16 mm	2000 42 x 16 mm 2001 56 x 16 mm	2000 42 x 16 mm 2001 56 x 16 mm	2000 42 x 16 mm 2001 56 x 16 mm
leverlengte 5000 mm	Lieferlänge 5000 mm	standard length 5000 mm	longueur standard 5000 mm
geanodiseerd -11 mat naturel	eloxiert -11 matt silber	anodized -11 matt silver	anodisé -11 argent mat

LEGPROFIEL	ABLAGEPROFIL	FRONTRAIL	PROFIL PORTE CHAPEAU
aluminium profiel	Aluminiumprofil	aluminium profile	en profilé d'aluminium
2005 13 x 18 mm	2005 13 x 18 mm	2005 13 x 18 mm	2005 13 x 18 mm
leverlengte 5000 mm	Lieferlänge 5000 mm	standard length 5000 mm	longueur standard 5000 mm
geanodiseerd -11 mat naturel	eloxiert -11 matt silber	anodized -11 matt silver	anodisé -11 argent mat

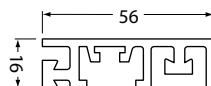
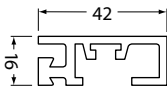

STEUNEN | GARDELUX 2

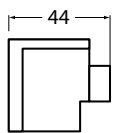
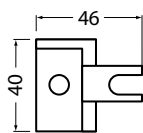

2015

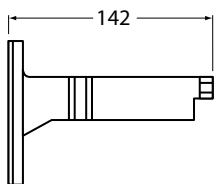
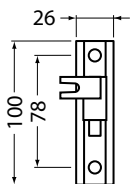

2091

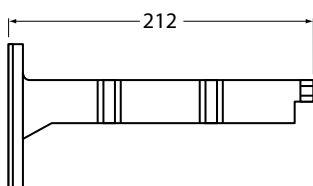
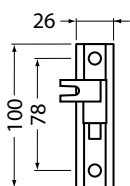

2096

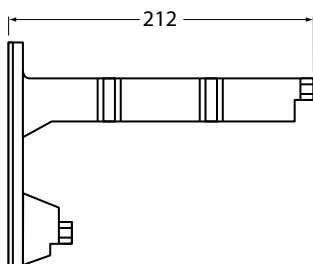
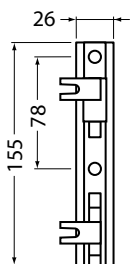

2092

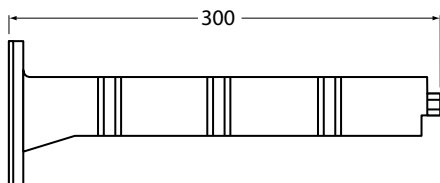
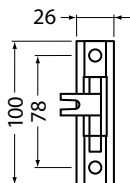

2093

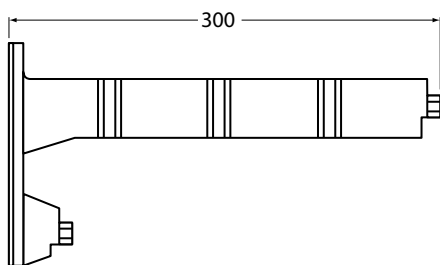
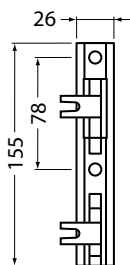

2094



STEUNEN | GARDELUX 2

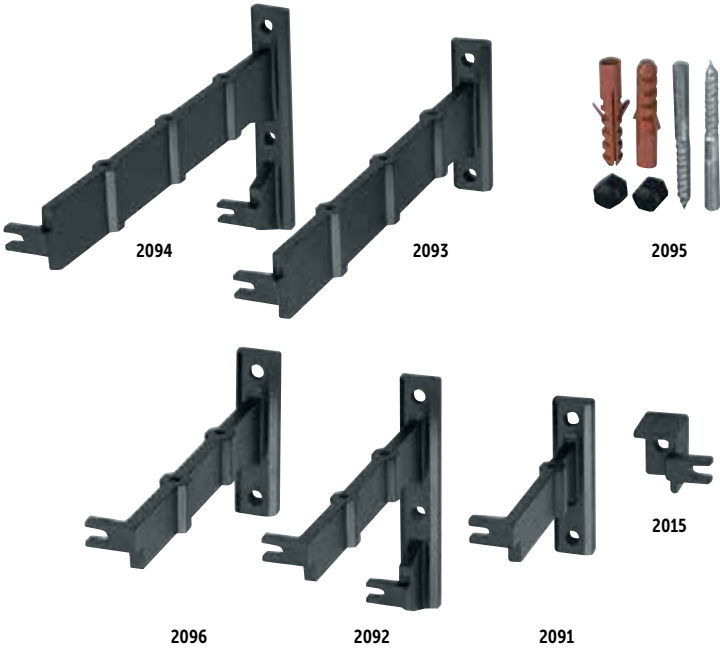

STEUNEN	TRÄGER	BRACKETS	SUPPORTS
gegoten aluminium	Aluminiumguss	cast aluminium	en fonte d'aluminium

Inclusief bevestigingsmateriaal voor montage van garderobelijsten en legprofielen

einschliesslich Befestigungsmaterial für Montage von Garderobenleisten und Ablageprofilen

including front and shelf rails fixings

visserie pour la pose des profilés inclus

geëpoxideerd
-70 zwart

pulverbeschichtet
-70 schwarz

epoxy plastic coated
-70 black

thermolaqué
-70 noir

MONTAGESET VOOR STEUNEN	MONTAGEZUBEHÖR FÜR TRÄGER	FIXING KIT FOR BRACKETS	FIXATIONS POUR SUPPORTS
inhoud: 2 pluggen 2 stokschroeven M8 x 70 mm 2 dopmoeren M8	Inhalt: 2 Dübel 2 Stokschrauben M8 x 70 mm 2 Hutmuttern M8	contents: 2 plugs 2 threaded screws M8 x 70 mm 2 M8 domeheaded nuts	composition: 2 chevilles 2 vis captives M8 x 70 mm 2 écrous borgnes M8
2095-18 zwart	2095-18 schwarz	2095-18 black	2095-18 noir

inhoud:
2 pluggen
2 stokschroeven
M8 x 70 mm
2 dopmoeren M8

Inhalt:
2 Dübel
2 Stokschrauben
M8 x 70 mm
2 Hutmuttern M8

contents:
2 plugs
2 threaded screws
M8 x 70 mm
2 M8 domeheaded nuts

composition:
2 chevilles
2 vis captives
M8 x 70 mm
2 écrous borgnes M8

2095-18 zwart

2095-18 schwarz

2095-18 black

2095-18 noir



GARDEROBEHAKEN GARDELUX 2

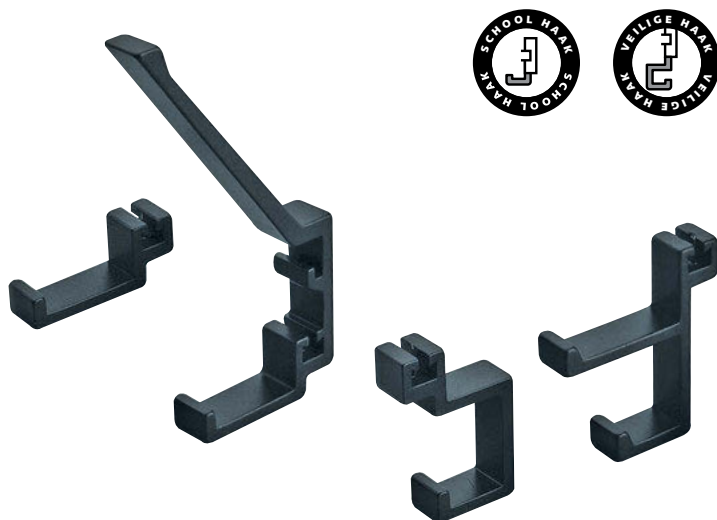

2081

2082

2083

2085

GARDEROBEHAKEN	GARDEROBENHAKEN	HAT AND COAT HOOKS	CROCHETS DE VESTIAIRE
aluminium profiel	Aluminiumprofil	extruded aluminium	en profilé aluminium
met borgschroefje	mit Fixier-schraube	with locking screw	avec vis de serrage
geanodiseerd	eloxiert	anodized	anodisé
-11 mat naturel	-11 matt silber	-11 matt silver	-11 argent mat
-18 zwart	-18 schwarz	-18 black	-18 noir

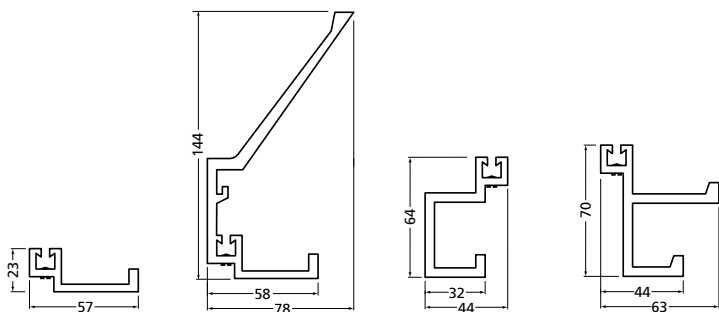

KLEDINGHANGERS | INHAAKOOG GARDELUX 2



KLEDINGHANGERS	KLEIDERBÜGEL	COAT HANGERS	CINTRES
----------------	--------------	--------------	---------

aluminium	Aluminium	aluminium	aluminium
1262 zelfrichtend	1262 selbstrichtend	1262 selfaligning	1262 non pivotant
1264 niet uitneembaar incl. inhaakooeg 2111	1264 nicht abnehmbar einschl. Aufhängeöse 2111	1264 captive hanger incl. hangerhook 2111	1264 cintre anti-vol crochet 2111 inclus
geanodiseerd haak zwart: -11 mat naturel	eloxiert Haken schwarz: -11 matt silber	anodized hook black: -11 matt silver	anodisé crochet noir: -11 argent mat

INHAAKOOG	AUFHÄNGEÖSE	COAT HANGER HOOK	OUILLET POUR CINTRE
-----------	-------------	------------------	---------------------

kunststof	Kunststoff	plastic	en matière plastique
2111 met borgschroefje	2111 mit Fixier-schraube	2111 with locking screw	2111 avec vis de serrage
-80 zwart	-80 schwarz	-80 black	-80 noir

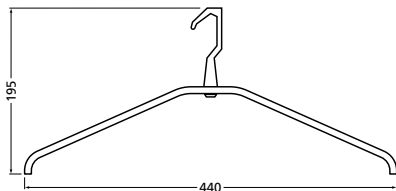
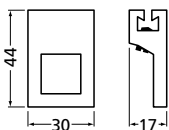

EINDSTOPS | GARDELUX 2

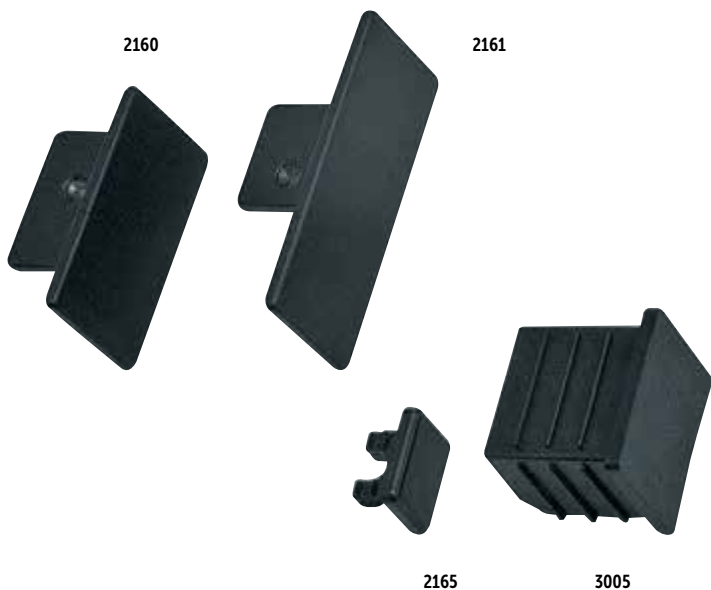

EINDSTOPS	ENDKAPPEN	END CAPS	EMBOUS
aluminium	Aluminium	aluminium	aluminium
voor garderobelijst:	für Garderobenleiste:	for front rail:	pour profil de vestiaire:
2160 voor 2000 2161 voor 2001	2160 für 2000 2161 für 2001	2160 for 2000 2161 for 2001	2160 pour 2000 2161 pour 2001
geanodiseerd -18 zwart	eloxiert -18 schwarz	anodized -18 black	anodisé -18 noir
kunststof	Kunststoff	plastic	plastique
voor legprofiel:	für Ablageprofil:	for shelf rails:	pour profils porte-chapeau:
2165 voor 2005 3005 voor 3000	2165 für 2005 3005 für 3000	2165 for 2005 3005 for 3000	2165 pour 2005 3005 pour 3000
-80 zwart	-80 schwarz	-80 black	-80 noir

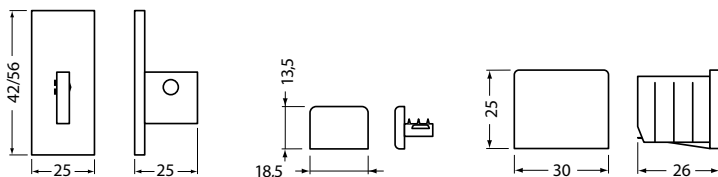

TOEBEHOREN | GARDELUX 2



2130



2131



2150



2151

VERBINDINGSSTUKKEN	VERBINDUNGSSTÜCKE	CONNECTION PIECES	RACCORDS
aluminium	Aluminium	aluminium	aluminium
2130 voor garderobelijst 2000 2131 voor garderobelijst 2001	2130 für Garderobenteleiste 2000 2131 für Garderobenteleiste 2001	2130 for front rail 2000 2131 for front rail 2001	2130 pour profils de vestiaire 2000 2131 pour profils de vestiaire 2001
geëpoxideerd -70 zwart	pulverbeschiktet -70 schwarz	epoxy plastic coated -70 black	thermolaqué -70 noir

T-VERBINDING	T-VERBINDER	T-CONNECTOR	RACCORD EN T
aluminium	Aluminium	aluminium	aluminium
2150-96 T-verbinding garderobelijst 2000 legprofiel 2005. 2151-96 T-verbinding garderobelijst 2001 legprofiel 2005.	2150-96 T-Verbinder für Garderobenteleiste 2000 Ablageprofil 2005. 2151-96 T-Verbinder für Garderobenteleiste 2001 Ablageprofil 2005.	2150-96 T-connector for front rail 2000 and shelf rail 2005. 2151-96 T-connector for front rail 2001 and shelf rail 2005.	2150-96 raccord en T pour profilés 2000 avec 2005. 2151-96 raccord en T pour profilés 2001 avec 2005.

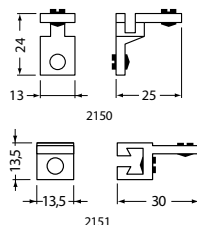
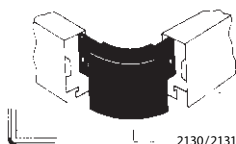
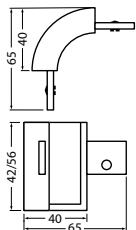

TOEBEHOREN | GARDELUX 2



HAKENSTRIP	HAKENLEISTE	COAT HOOK STRIP	BARRE PORTECROCHETS
<p>2350-21 zwart geëpoxeerd 25 x 5 mm stalen strip met 4 naturel geanodiseerde aluminium dubbele jashaken.</p>	<p>2350-21 Leiste aus Stahlblech 25 x 5 mm, schwarz pulverbeschichtet. 4 silber eloxierte Aluminium Doppelhaken.</p>	<p>2350-21 Steel strip 25 x 5 mm, black epoxy plastic coated, with 4 silver anodized aluminium double coat hooks.</p>	<p>2350-21 en acier 25 x 5 mm thermolaqué noir, avec 4 crochets doubles en fonte d'aluminium anodisé argent.</p>
ACHTERPLAAT VOOR STEUN	BEFESTIGINGSWINKEL	BACKPLATE FOR FIXING BOTTOM RAIL	SUPPORT
<p>2351-70 staal zwart geëpoxeerd, montageplaat voor framemontage van Type R. 2354-70 staal zwart geëpoxeerd, montageplaat voor wand- en framemontage van Type 12.</p>	<p>2351-70 Stahl schwarz pulverbeschichtet, Montageplatte für Rahmenmontage Typ R. 2354-70 Stahl schwarz pulverbeschichtet, Montageplatte für Wand- und Rahmenmontage von Type 12.</p>	<p>2351-70 steel black epoxy plastic coated, mounting plate for frame mounting type R. 2354-70 steel black epoxy plastic coated, mounting plate for wall and frame mounting of type 12.</p>	<p>2351-70 acier époxy noir, plaque de montage pour montage sur cadre de Type R. 2354-70 acier époxy noir, plaque de montage pour montage mural et sur cadre de Type 12.</p>
STEUN VOOR GARDEROBELIJST	STÜTZE FÜR GÄRDEROBENLEISTE	BRACKET FOR BOTTOM RAIL	SUPPORT POUR PROFIL DE VESTIAIRE
<p>2352-18 van aluminium profiel, zwart geanodiseerd, met borschroefje. Alleen te gebruiken bij wandmontage Type R.</p>	<p>2352-18 aus Alu-Profil, schwarz eloxiert, mit Fixierschraube. Nur zu verwenden bei Wandmontage Typ R.</p>	<p>2352-18 Made of extruded aluminium, black anodized, with locking screw. Only for use when fixing to walls type R.</p>	<p>2352-18 en profilé d'aluminium, noir. Vis de serrage inclus. Seulement pour fixation du vestiaire contre le paroi de Type R.</p>

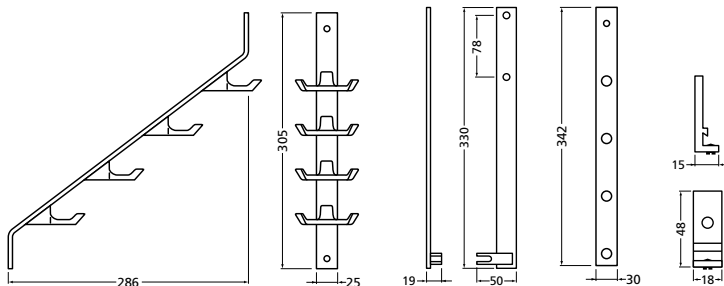

NUMMERPLAATJES

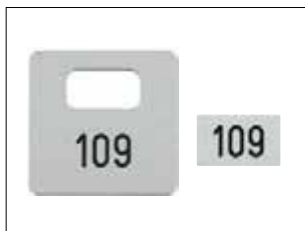

2100



2105

NUMMERPLAATJES	GARDEROBENMARKE	CLOAK ROOM NUMBERPLATES	NUMEROS DE VESTIAIRE
kunststof	Kunststoff	plastic	en matière plastique
<p>2100 voor uitgifte aan bezoekers 2105 zelfklevend voor bevestiging op garderobelijst</p> <p>-11 zilver met zwarte cijfers</p> <p>-80 zwart met witte cijfers</p>	<p>2100 für Ausgabe an Besucher 2105 (selbstklebend) für Befestigung auf die Garderobenteiste</p> <p>-11 matt silber mit schwarzen Zahlen</p> <p>-80 schwarz mit weißen Zahlen</p>	<p>2100 for handing to visitor 2105 (self adhesive) for fixing to front rail</p> <p>-11 matt silver with black numbers</p> <p>-80 black with white numbers</p>	<p>2100 pour l'utilisateur 2105 (auto-collant) pour fixation sur profil de vestiaire</p> <p>-11 argent mat avec chiffres noirs</p> <p>-80 noir avec chiffres blancs</p>





9 **Zitbanken**

9 **Sitzbänke**

9 **Benches**

9 **Bancs**



ZITBANKEN



type 1

ZITBANKEN	SITZBÄNKE	BENCHES	BANCS
Type 1 is te leveren met hardhouten of aluminium zitting.	Typ 1 ist mit einer Sitzfläche aus Hartholz oder Aluminium lieferbar.	Type 1 is available with a hardwooden or aluminium seat.	Modèle 1 est livrable avec des sièges en bois tropical ou en aluminium.
Standaard lengtematen: 1150 en 2150 mm.	Standardlängen: 1150 und 2150 mm.	Standard lengths: 1150 and 2150 mm.	Les longueurs standard sont de 1150 et 2150 mm.
Ook leverbaar in elke gewenste lengte tot 4800 mm.	Darüber hinaus in jeder gewünschten Länge bis 4800 mm lieferbar.	Also available in any chosen length to a maximum of 4800 mm.	Il est aussi possible d'obtenir des bancs de toutes les longueurs désirées jusqu'à un maximum de 4800 mm.
-70 zwart RAL 9005	-70 schwarz RAL 9005	-70 black RAL 9005	-70 noir RAL 9005

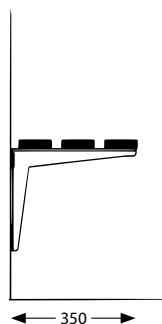

ZITBANKEN



type 3

ZITBANKEN	SITZBÄNKE	BENCHES	BANCS
Type 3 is te leveren met hardhouten of aluminium zitting.	Typ 3 ist mit einer Sitzfläche aus Hartholz oder Aluminium lieferbar.	Type 3 is available with a hardwooden or aluminium seat.	Modèle 3 est livrable avec des sièges en bois tropical ou en aluminium.
Standaard lengtematen: 1150 en 2150 mm, met of zonder schoenenrek.	Standardlängen: 1150 und 2150 mm, mit oder ohne Schuhe Rack.	Standard lengths: 1150 and 2150 mm, with or without shoes rack.	Les longueurs standard sont de 1150 et 2150 mm, avec ou sans bac à chaussures.
Ook leverbaar in elke gewenste lengte tot 4800 mm.	Darüber hinaus in jeder gewünschten Länge bis 4800 mm lieferbar.	Also available in any chosen length to a maximum of 4800 mm.	Il est aussi possible d'obtenir des bancs de toutes les longueurs désirées jusqu' à un maximum de 4800 mm.
-70 zwart RAL 9005	-70 schwarz RAL 9005	-70 black RAL 9005	-70 noir RAL 9005

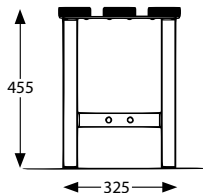

ZITBANKEN MET GARDEROBE



type 5

ZITBANKEN MET GARDEROBE	SITZBÄNKE MIT GARDEROBE	BENCHES WITH COAT RACK	BANCS AVEC VESTIAIRE
Type 5 is te leveren met hardhouten of aluminium zitting.	Typ 5 ist mit einer Sitzfläche aus Hartholz oder Aluminium lieferbar.	Type 5 is available with a hardwooden or aluminium seat.	Modèle 5 est livrable avec des sièges en bois tropical ou en aluminium.
Standaard lengtematen: 1150 en 2150 mm, met of zonder schoenenrek.	Standardlängen: 1150 und 2150 mm, mit oder ohne Schuhe Rack.	Standard lengths: 1150 and 2150 mm, with or without shoes rack.	Les longueurs standard sont de 1150 et 2150 mm, avec ou sans bac à chaussures.
Ook leverbaar in elke gewenste lengte tot 4800 mm.	Darüber hinaus in jeder gewünschten Länge bis 4800 mm lieferbar.	Also available in any chosen length to a maximum of 4800 mm.	Il est aussi possible d'obtenir des bancs de toutes les longueurs désirées jusqu' à un maximum de 4800 mm.
-70 zwart RAL 9005	-70 schwarz RAL 9005	-70 black RAL 9005	-70 noir RAL 9005



ZITBANKEN MET GARDEROBE



type 6

ZITBANKEN MET GARDEROBE	SITZBÄNKE MIT GARDEROBE	BENCHES WITH COAT RACK	BANCS AVEC VESTIAIRE
Type 6 is te leveren met hardhouten of aluminium zitting.	Typ 6 ist mit einer Sitzfläche aus Hartholz oder Aluminium lieferbar.	Type 6 is available with a hardwooden or aluminium seat.	Modèle 6 est livrable avec des sièges en bois tropical ou en aluminium.
Standaard lengtematen: 1150 en 2150 mm, met of zonder schoenenrek.	Standardlängen: 1150 und 2150 mm, mit oder ohne Schuhe Rack.	Standard lengths: 1150 and 2150 mm, with or without shoes rack.	Les longueurs standard sont de 1150 et 2150 mm, avec ou sans bac à chaussures.
Ook leverbaar in elke gewenste lengte tot 4800 mm.	Darüber hinaus in jeder gewünschten Länge bis 4800 mm lieferbar.	Also available in any chosen length to a maximum of 4800 mm.	Il est aussi possible d'obtenir des bancs de toutes les longueurs désirées jusqu'à un maximum de 4800 mm.
-70 zwart RAL 9005	-70 schwarz RAL 9005	-70 black RAL 9005	-70 noir RAL 9005

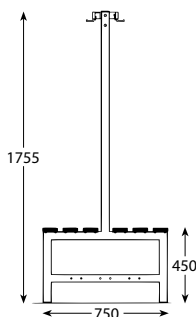

STEUNEN VOOR ZITBANKEN



STEUNEN EN VERBINDINGSREGELS VOOR ZITBANKEN	TRÄGER UND VERBINDUNGSSATZ FÜR SITZBÄNKE	SUPPORTS AND CONNECTING TUBES FOR BENCHES	SUPPORTS ET BARRES DE RACCORDEMENT LATÉRALES POUR BANCS
3061 voor bank type 1 3063 voor bank type 3	3061 für Bänke Typ 1 3063 für Bänke Typ 3	3061 for bench type 1 3063 for bench type 3	3061 pour banc modèle 1 3063 pour banc modèle 3
verbindingsregels voor 3063 : 1338 L=700mm 1339 L=970mm	verbindingssatz für 3063 : 1338 L=700mm 1339 L=970mm	connecting tubes for 3063 : 1338 L=700mm 1339 L=970mm	barres pour 3063 : 1338 L=700mm 1339 L=970mm
staal geëpoxeerd -70 zwart RAL 9005	staal pulverbeschikt -70 schwarz RAL 9005	steel epoxy plastic coated -70 black RAL 9005	en acier thermolaqué -70 noir RAL 9005

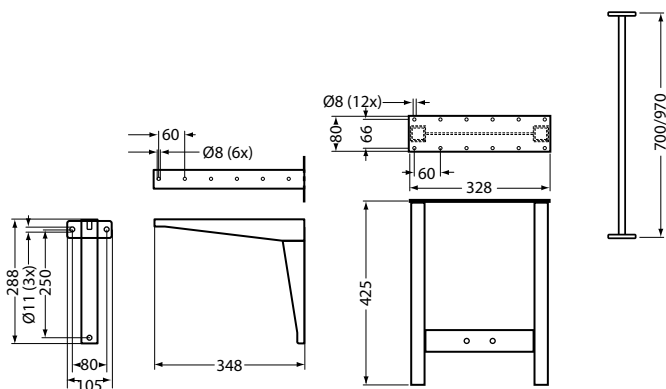

STANDAARD VOOR ZITBANKEN MET GARDEROBE

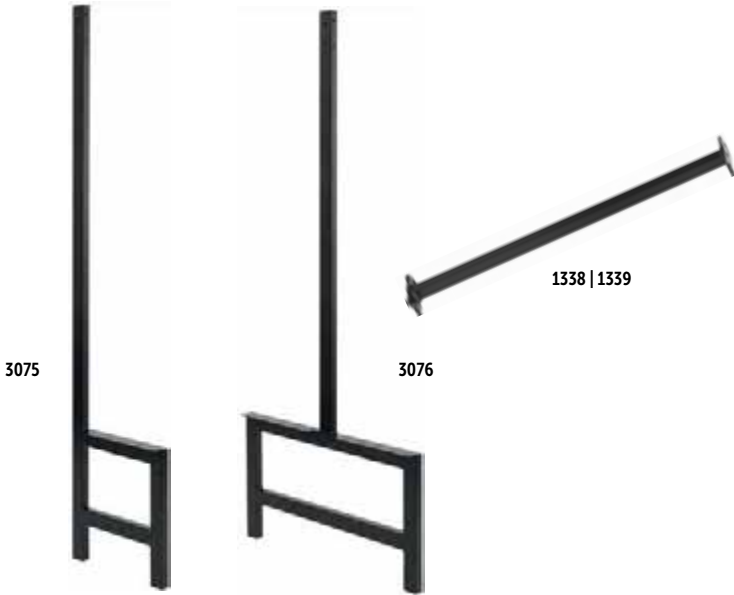

STEUNEN EN VERBINDINGSREGELS VOOR ZITBANKEN MET GARDEROBE	TRÄGER UND VERBINDUNGSSATZ FÜR SITZBÄNKE MIT GARDEROBE	SUPPORTS AND CONNECTING TUBES FOR BENCHES WITH COAT RACK	SUPPORTS ET BARRES DE RACCORDEMENT LATÉRALES POUR BANCS AVEC VESTIAIRE
3075 voor bank type 5 3076 voor bank type 6	3075 für Bänke Typ 5 3076 für Bänke Typ 6	3075 for bench type 5 3076 for bench type 6	3075 pour banc modèle 5 3076 pour banc modèle 6
verbindingsregels 1338 L=700mm 1339 L=970mm	verbindingssatz 1338 L=700mm 1339 L=970mm	connecting tubes 1338 L=700mm 1339 L=970mm	barres 1338 L=700mm 1339 L=970mm
staal geëpoxeerd -70 zwart RAL 9005	staal pulverbeschiktet -70 schwarz RAL 9005	steel epoxy plastic coated -70 black RAL 9005	en acier thermolaqué -70 noir RAL 9005

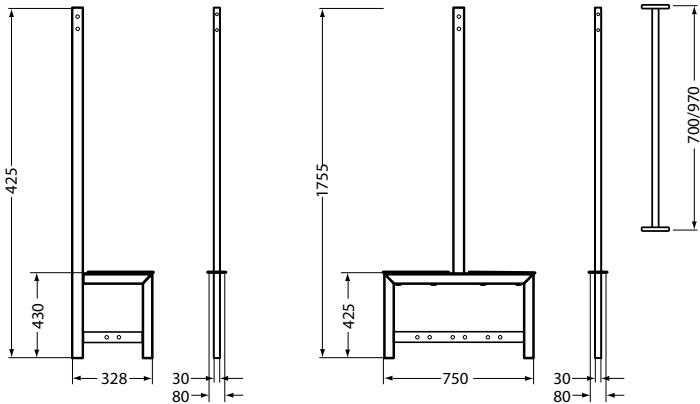

BANKPROFIELEN EN ZITDELEN



ZITDEEL	SITZLEISTE	RAIL FOR BENCHES	LATTE POUR BANCS
van hardhout	aus hartholz	hardwood	en bois tropical
3007 90 mm breed 25 mm dik Standaard lengtematen 1150 en 2150 mm. Ook leverbaar in elke gewenste lengte tot 4800 mm	3007 90 mm Breite 25 mm Dick Standardlängen 1150 und 2150 mm. Darüber hinaus in jeder gewünschten Länge bis 4800 mm lieferbar	3007 90 mm wide 25 mm thick Standard lengths 1150 and 2150 mm. Also available in any chosen length to a maximum of 4800 mm	3007 90 mm largeur 25 mm épaisseur Les longueurs standard sont de 1150 et 2150 mm. Aussi de toutes les longueurs désirées jusqu'à un maximum de 4800 mm
BANKPROFIEL	SITZLEISTE	RAIL FOR BENCHES	LATTE POUR BANCS
aluminium profiel	Aluminiumprofil	aluminium profile	en aluminium profilé
3000 25 x 30 mm leverlengte 5000 mm geanodiseerd, -11 mat naturel	3000 25 x 30 mm Lieferlänge 5000 mm eloxiert -11 matt silber	3000 25 x 30 mm standard length 5000 mm anodized -11 matt silver	3000 25 x 30 mm longueur standard 5000 mm anodisé -11 argent mat
EINDSTOP	ENDKAPPE	END CAP	EMBOUT
kunststof	kunststoff	plastic	plastique
3005 (voor profiel 3000) -80 zwart	3005 (für profiel 3000) -80 schwarz	3005 (for rail 3000) -80 black	3005 (pour profiel 3000) -80 noir

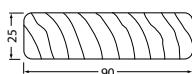





**10 Garderobeframes
en kapstokken**

**10 Rahmen für Garderoben
und Garderobenständer**

**10 Frames
and coat stands**

**10 Adres de vestiaire
et porte-manteaux à pied**



GARDEROBEFRAMES

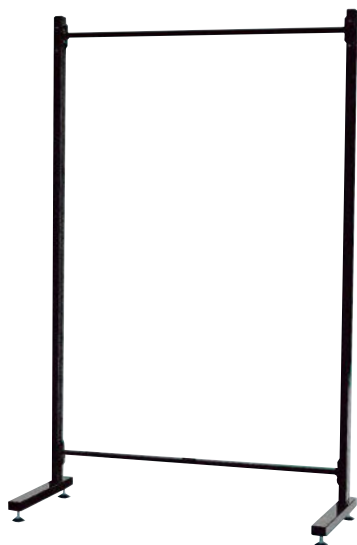

FRAMES ENKELZIJDIG	RAHMEN EINSEITIG	FRAMES SINGLE SIDED	CADRES D'UN SEUL CÔTÉ
standaards en verbindingsregels van stalen kokerprofiel	Ständer und Verbindungssatz aus Stahlrohr	steel uprights and connecting tubes	piliers et barres de raccordement laterales, en acier
enkelzijdige staander 1333 H=1750mm	einseitiger Ständer 1333 H=1750mm	single sided stand 1333 H=1750mm	support à un seul côté 1333 H=1750mm
verbindingsregels 1338 L=700mm 1339 L=970mm	verbindungssatz 1338 L=700mm 1339 L=970mm	connecting tubes 1338 L=700mm 1339 L=970mm	barres 1338 L=700mm 1339 L=970mm
N.B. Stelvoeten, of zwenkwielen apart bestellen. (pag. 142)	Achtung: Stellfüsse, oder Lenkrollen müssen zusätzlich bestellt werden. (Seite 142)	Note: Adjustable feet, or castors to be ordered seperately. (page 142)	Attention: des pieds et des roulettes pivotantes sont à commander selon votre besoin. (page 142)
geëpoxideerd -70 zwart RAL 9005	pulverbeschichtet -70 schwarz RAL 9005	epoxy plastic coated -70 black RAL 9005	thermolaqué -70 noir RAL 9005

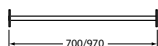
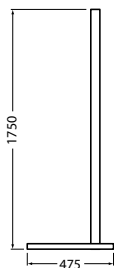

GARDEROBEFRAMES

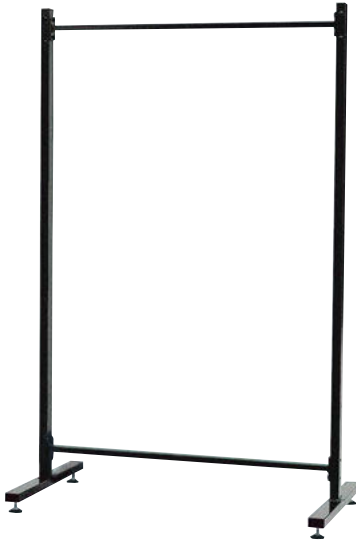

FRAMES DUBBELZIJDIG	RAHMEN DOPPELSEITIG	FRAMES DOUBLE SIDED	CADRES DES DEUX CÔTÉ
standaards en verbindingsregels van stalen kokerprofiel	Ständer und Verbindungssatz aus Stahlrohr	steel uprights and connecting tubes	piliers et barres de raccordement laterales, en acier
dubbelzijdige staander 1337 H=1750mm	doppelseitiger Ständer 1337 H=1750mm	double sided stand 1337 H=1750mm	support à deux seul côté 1337 H=1750mm
verbindingsregels 1338 L=700mm 1339 L=970mm	verbindungssatz 1338 L=700mm 1339 L=970mm	connecting tubes 1338 L=700mm 1339 L=970mm	barres 1338 L=700mm 1339 L=970mm
N.B. Stelvoeten, of zwenkwielen apart bestellen. (pag. 142)	Achtung: Stellfüsse, oder Lenkrollen müssen zusätzlich bestellt werden. (Seite 142)	Note: Adjustable feet, or castors to be ordered seperately. (page 142)	Attention: des pieds et des roulettes pivotantes sont à commander selon votre besoin. (page 142)
geëpoxideerd -70 zwart RAL 9005	pulverbeschichtet -70 schwarz RAL 9005	epoxy plastic coated -70 black RAL 9005	thermolaqué -70 noir RAL 9005

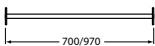
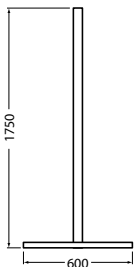

STELVOETEN EN ZWENKWIELEN



1355



1356



1366

STELVOET	STELLFUSS	ADJUSTABLE FOOT	PIED REGLABLE
1366-80 met M10 draadeind, zwarte kunststof schotel	1366-80 mit M10 Gewinde, Stellfuss Kunststoff schwarz	1366-80 with M10 threaded rod, black plastic foot	1366-80 avec tige fileté M10, pied en plastique noir
ZWENKWIEL	LENKROLLE	CASTOR	ROULETTE PIVOTANTE
gegalvaniseerd staal met M10 draadeind	verzinkt Stahblech mit Gewinde M10	galvanized steel with M10 threaded rod	en acier galvanisé avec tige fileté M10
1355-99 zonder rem 1356-99 met rem	1355-99 ohne Bremse 1356-99 mit Bremse	1355-99 without brake 1356-99 with brake	1355-99 sans frein 1356-99 avec frein

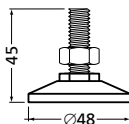
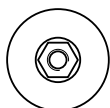

STAANDE KAPSTOK



2250-74

2250-79

STAANDE KAPSTOK	FREISTEHENDER GARDEROBENSTÄNDER	COAT STAND	PORTE-MANTEAU À PIED
aluminium	Aluminium	aluminium	aluminium
<p>Staande kapstok met 8 dubbele jas-/hoedhaken, ronde kroon van gegoten aluminium, staander en haken naturel geanodiseerd, hoog 1800 mm</p> <p>2250-74 kroon en voet grafiet grijs 2250-79 kroon en voet puur wit</p>	<p>Freistehender Garderobenständer mit 8 doppel Mantel- und Huthaken, runde Krone aus gegossenem Aluminium, Ständer und Haken natürel eloxiert, Höhe 1800 mm</p> <p>2250-74 Krone und Fuss graphit grau 2250-79 Krone und Fuss reines weiß</p>	<p>Coat stand with 8 double coat and hat hooks, round crown of cast aluminium, stands and hooks silver anodized, height 1800 mm</p> <p>2250-74 crown and base graphite grey 2250-79 crown and base pure white</p>	<p>Porte-manteau à pied avec 8 double crockets porte manteau et porte chapeau, couronne circulaire d'aluminium coule, support et crochets anodisé de façon naturelle, hauteur 1800 mm</p> <p>2250-40 couronne et pied gris graphite 2250-79 couronne et pied blanc pur</p>



NUMMERREGISTER

0028	12	1196	101
0029	12	1199	105
0030	13	1201	107
0031	13	1205	30
0032	14	1221	107
0033	14	1231	107
0111	15	1262	108, 123
0115	15	1264	123
0129	16	1266	108
0138	17	1333	140
0139	17	1337	141
0148	18	1338	134, 135, 140, 141
0149	18	1339	134, 135, 140, 141
0150	19	1355	142
0200	20	1356	142
0201	20	1366	142
0202	21	1900-1909	29
0551	24	2000	119
0553	24	2001	119
0554	25	2005	119
0555	25	2015	121
0557	26	2081	122
0559	26	2082	122
0560	26	2083	122
0591	30	2085	122
0652-0655	27	2091	121
0683	28	2092	121
0685	28	2093	121
0820	22	2094	121
0822-0825	31	2095	105, 121
0860	22	2096	121
0862-0865	32	2100	127
0880	23	2105	127
0882-0885	33	2111	123
1010-1019	98	2130	125
1030	100	2131	125
1032	100	2150	125
1050	103	2151	125
1052	103	2160	124
1080-1082	103	2161	124
1090-1092	103	2165	124
1110-1112	105	2250	143
1140-1142	105	2350	126
1150-1152	106	2351	126
1170	99	2352	126
1175	99	2354	126
1190	101	2650	34
1192	101	2655	34
1194	101	2660	34



2670	34	4087	55
2680-2685	35	4089	55
3000	136	4192	56
3005	124, 136	4193	56
3007	136	4200-4205	57
3061	134	4231-4233	58
3063	134	4255-4258	59
3075	135	4265	60
3076	135	4268	60
3275	82	4270	60
3280	82	4321	73
3500	38	4550	61
3501	38	4552	61
3502	39	4554	64
3503	39	4555	64
3505	40	4556	65
3506	40	4558	65
3507	41	4560	66
3508	41	4562	66
3510	42	4565	61
3515	42	4566	61
3520	43	4700	70
3525	43	4702	70
3540	44	4704	70
3541	44	4709	70
3542	45	4735	71
3543	45	4760	72
3550	46	5855	83
3551	46	5865	83
3552	47	5866	83
3553	47	5900	84
3580	48	5935	84
3581	48		
3650	77		
3651	77		
3652	77		
3670	77		
3675	77		
3679	77		
3731	52		
3732	52		
3751-3753	53		
3755	54		
3850	77		
3851	77		
3852	77		
3870	77		
3875	77		
3879	77		







hermeta

Hermeta Metaalwaren bv

1e Industrieweg 1

4147 CR Asperen

Tel.: +31 (0) 345 63 48 74

sales@hermeta.nl

www.hermeta.nl



Uitgave 2023 | Hermeta bezit alle exclusieve rechten betreffende ontwerp, constructie en presentatie van de in deze catalogus afgebeelde artikelen. Gehele of gedeeltelijke overname is uitsluitend geoorloofd na verleende schriftelijke toestemming door Hermeta Metaalwaren bv te Asperen.

Afbeeldingen, afmetingen en uitvoering zoals in deze catalogus getoond, zijn niet bindend; publicatie vindt plaats onder voorbehoud.

Op al onze overeenkomsten zijn, tenzij schriftelijk anders is overeengekomen, de Algemene Leveringsvoorwaarden van de Vereniging Fabrieken van Hang- en Sluitwerk (VHS) en van de Vereniging Fabrikanten IJzerwaren en Gereedschappen (IJG), van toepassing. Deze zijn gedeponereerd bij de Arrondissementsrechtbank te 's Gravenhage op 22 maart 2001, onder nummer 38/2001.



Ausgabe 2023 | Hermeta besitzt alle Rechte bezüglich Entwurf, Konstruktion und Präsentation aller in diesem Katalog abgebildeten Artikel. Ganze oder teilweise Übernahme ist ausschließlich erlaubt nach schriftlich erteilte Zustimmung von Hermeta Metaalwaren bv in Asperen, Niederlande.

Abbildungen, Abmessungen und Ausführung in diesem Katalog sind unverbindlich. Veröffentlichung geschieht unter Vorbehalt.

Alle unsere Vereinbarungen unterliegen, sofern nicht anders vereinbart, den ALLGEMEINEN BEDINGUNGEN für die LIEFERUNG VON MECHANISCHEN, ELEKTRISCHEN UND ELEKTRONISCHEN ERZEUGNISSEN (ORGALIME S 2012). Orgalime ist der europäische Verband der Maschinenbau-, Elektro-, und Metallverarbeitungsindustrie.



Edition 2023 | Hermeta is in the possession of all exclusive rights regarding design, construction and presentation of the in this catalogue portrayed articles. Entirely or partial use is only permitted after granted permission in writing by Hermeta Metaalwaren bv in Asperen, Holland.

Pictures, dimensions and workmanship as shown in this catalogue are not binding; publication occurs with reservation.

All our agreements are, unless otherwise agreed, subject to the GENERAL CONDITIONS for the SUPPLY OF MECHANICAL, ELECTRICAL AND ELECTRONIC PRODUCTS (ORGALIME S 2012). Orgalime represents the mechanical, electrical, electronic and metalworking industries in Europe.



Edition 2023 | Hermeta est propriétaire exclusif des droits concernant les formes, les fabrications et les photographies publiées dans ce catalogue. L'utilisation partielle ou complète des photos ne pourra être effectuée sans un accord préalable et écrit de la société Hermeta Metaalwaren bv située à Asperen, Pays-Bas.

Les photographies et dimensions indiquées dans ce catalogue ne sont pas contractuelles.

Tous nos accords sont, sauf accord contraire, soumis à le CONDITIONS GÉNÉRALES pour la FOURNITURE DE PRODUITS MÉCANIQUES, ÉLECTRIQUES ET ÉLECTRONIQUES (ORGALIME S 2012). Orgalime regroupe les associations européennes des secteurs mécanique, électrique, électronique et de la transformation des métaux.



catalogus **2023** | **2024**

